

Table of Contents

Air Velocity 2-2

Ammonia Gas in Air Sensor 2-3

Carbon Dioxide Monitor 2-4

Flow Transmitter 2-5

Humidity

 Humidity/Temperature Transmitter 2-6

 Humidity/Temperature Transmitter for Stability 2-7

 DC-Input Dual Channel Signal Isolator 2-8

Relative Humidity Sensor (Wall Mount, Water Resistant) 2-9

Relative Humidity Transmitter (Wall Mount) 2-10

Light

 Light/Temperature/Humidity Modules 2-11

 Lighting Override Timer, Manual 2-12

Oxygen Monitor 2-13

Oxygen Sensor 2-14

Power Line Monitors

 115 Volts 2-15

 220/440 2-16

Pressure

 Large Diaphragm Pressure Switch 2-17

 Pressure Switch 2-18

 Differential Pressure Switch 2-19

 Negative to Positive Differential Pressure Switch 2-20

Rotation Sensor 2-21

Shaker Sensor 2-22

Surface Water Detector 2-23

Light Sensor 2-24

Temperature

 Ambient Temperature Sensor 2-25

 Cryogenic Thermistor Probe 2-26

 Thermistor Probes 2-27

 Temperature Stabilization (Equilization) Kit

 Glycol 2-28

 Temperature Stabilization Kit

 Sand 2-29

 RTD Temperature Sensor 2-30

 Thermocouple Amplifier 2-31

Gas

 Combustible Gas Sensor 2-32

Air Velocity

Air Velocity

Application:

This sensor is ideal for use in animal facilities. It allows you to read the number of 'room air changes per hour' directly, or to read air changes in 'feet per minute'. Other applications include supply and exhaust fan tracking, industrial hygiene and clean room systems, and manufacturing or process control.

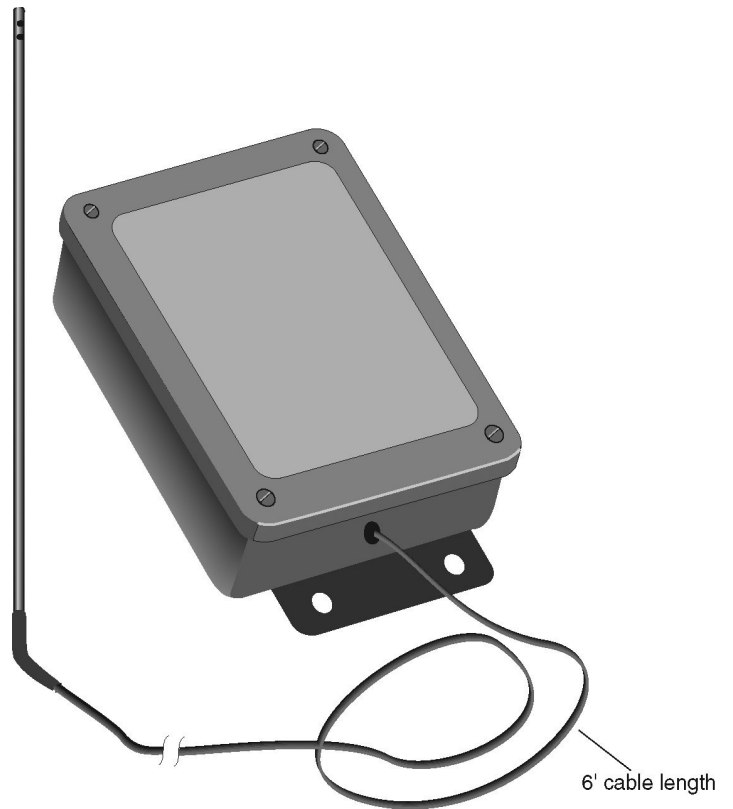

7.5" H x 4.5" W x 3.13" D
(Box and mounting brackets)
Probe is 12" long, 5/16" diam.

Specifications:

Operating Voltage: 18-24 VAC (Transformer is supplied with sensor.)

Current: 250 mA max.

Output signal: (249W load)

Zero output => 4mA

Full Span => 20 mA (Field selectable 200/1000 FPM)

Accuracy: (% of full scale)

0 -200 fpm range: ± 5% @ 32-180° F.

± 9% @ 0 - 32° F. or 180 - 200° F.

0 -1000 fpm range: ± 2% @ 32-180° F.

± 6% @ 0 - 32° F. or 180 - 200° F.

Dimensions:

Mechanical:

12" probe length

Cable: 6' cable length

Type	Order #
Standard: Use with Centron	AIRVEL
Calibration of Air Velocity Sensor. Customer to Supply Calibration Instrument.	CAL- AIRVEL

Ammonia

Ammonia Gas in Air Sensor

Application:

As more and more facilities install ventilated cage rack systems for animal research, new monitoring concerns often arise. One of the issues is room ammonia levels. The common goal of facilities using ventilated cage racks is to cut down on the number of bedding changes. By circulating cool, clean air into the individual cages, technicians feel they can significantly extend the life of the bedding, sometimes up to 2 to 3 weeks. By extending bedding life, institutions can reduce labor and materials costs.

Most of the current rack systems on the market circulate air from within the room through the racks and cages. The exhaust air is then blown from the rack into the room. The facilities HVAC system will then circulate clean air into the room. When the bedding life is extended, you can expect an increase in ammonia levels. By placing an ammonia sensor in the room or duct, you can make a better determination of when the cages need to be changed.

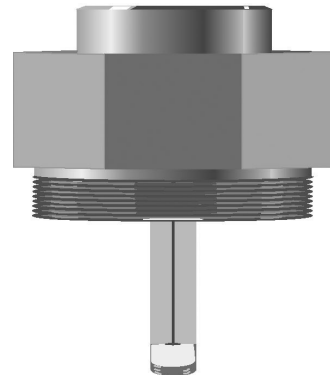
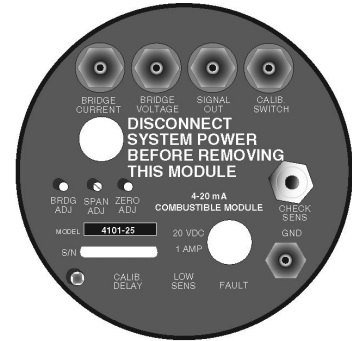

Specifications:

Dimensions: 8.8" x 4.0" x 4.2"

- Sensor Type:** Electrochemical
- Range:** 0-50 PPM
- Resolution:** 0.5 PPM
- Response time:** 90% ,30 sec.
- Sensor Life:** 1 year
- Operating temperature:** 14° to +113°F. (-10° to + 45° C)
- Relative Humidity:** 20 - 90%
- Weight:** 2.1 lb.
- Calibration frequency:** 90 days recommended
- Electrical data:**
 - Loop type: 3 wire
 - Loop resistance: 800 Ohms at 28 VDC
 - Input voltage VDC: 14-30
 - Input current: 40mA
 - Input power (max): 14 W
 - Signal output - Normal: 4 - 20mA DC linear
 - Signal output - Trouble: 0mA
- Operating pressure:** +10% (variation from ambient)
- Housing:** Explosion proof (NEMA 7)
- Warranty:** 1 year

Type	Order #
Ammonia gas in air sensor	AMMONIA-1

Carbon Dioxide Monitor

Application:

Carbon Dioxide transmitters are designed to measure CO₂ in harsh environments such as incubators and greenhouses. The materials are corrosion resistant and the housing is dust and water resistant to NEMA 4/IP65 standards. The transmitters are suited for safety alarming, leakage monitoring, and demand control ventilation in harsh environments.

This sensor has outstanding stability over both time and temperature. Longer time between calibration intervals saves both time and money.

There is a choice of measurement ranges up to 20% CO₂. The transmitter probes are interchangeable and they facilitate easy field maintenance. Probes can be returned for recalibration.

Note: A battery back-up is recommended for every four sensors.

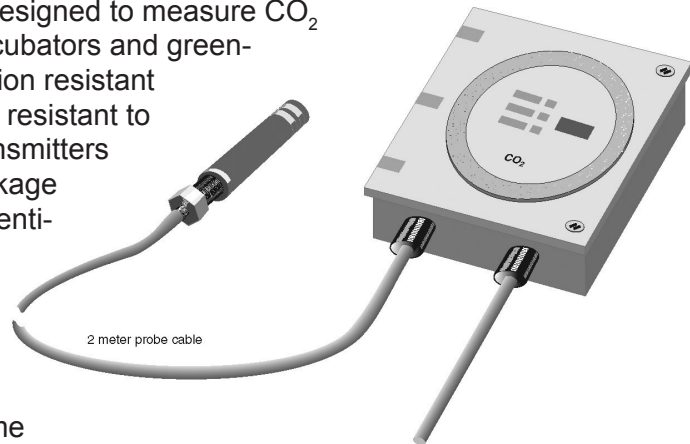

Specifications:

Dimensions: 4.69" x 4.69" x 1.25" deep

Measurement range: 0 - 20%

Accuracy: at 77° F (+25° C) < ±[0.02% CO₂ + 2% of reading]
(incl. repeatability & calibration uncertainty)

Nonlinearity: <±0.5%FS

Temperature dependence of output (typical value): -0.05% FS/°F (-0.1% FS/°C)

Pressure dependence (typ.): -0.15% of readings/hPa

Long term stability: <±5% FS/2 years

Response time (63%): 20 seconds

Analog output signals: 0 to 20 or 4 to 20 mA, and 0 to 10 V

Power supply: nominal 24 VAC/DC; max 30VAC/60VDC, 0.5A

Warm-up time: < 15 minutes

Operating temperature range: -4° to +140°F (-20° to +60° C)

Storage temperature range: -22° to +158°F (-30° to +70° C)

Operating humidity range: 0 to 100% RH non-condensing

Type	Order #
Standard: Use with Centron	CO2-MON
Battery back-up	HUM-BAT-BACK
Calibration of CO2 Sensor using an NIST traceable instrument.	CAL-CO2

Application:

Measure the flow of a liquid in pipes to an animal room, or any location.

Flow transmitters require pipe fittings which are not supplied. See Flow Transmitter fittings.

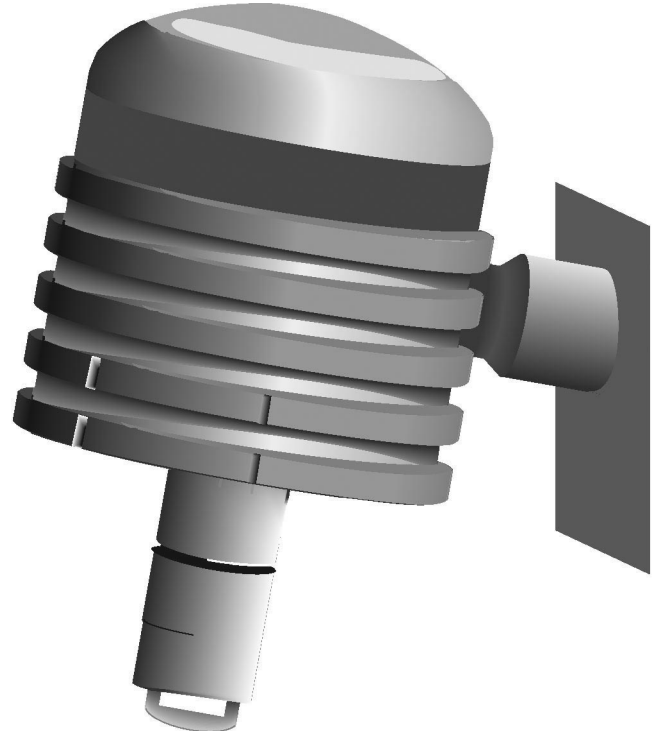

Specifications:

Dimensions: 5.75”H x 6.375” Diam.

- Housing Material:** Polypro
- Bearing Material:** at 95% Alumina Ceramic
- Pipe Size:** 1/2” to 4”
- Sensor O.D. :** 1.05”
- Sensor Length:** 3.50”
- Output:** 4-20mA
- Paddlewheel Sensor:**
Range: ±1.0 FPS to 12 FPS Std. to 20 FPS opt.
- Linearity:** ±1% over full range
- Repeatability:** ±1/2% over full range
- Accuracy:** ±1% over full range
- Pressure Rating:** 200 psig at 25° C
- Temperature Rating:** 212° F at 50 PSIG (requires metal fitting)
180° F at 25PSIG (CPVC fitting)
- Max % Solids:** 1% of fluid volume

Type	Order #
Standard: Use with Centron	FLOW-1

Humidity

Temperature/Humidity Transmitter

Application:

This temperature/humidity transmitter is used in reach-in stability chambers and incubators. Its small sensor head responds quickly to surrounding temperature changes.

Note: A battery back-up is recommended for every four sensors.



Specifications: **Dimensions:** 145 mm W x 120mm H x 65mm D, excluding probes

Relative Humidity

Measurement range: 0 to 100%

Accuracy (including nonlinearity and repeatability).

Maximum achievable when calibrated against high quality, certified humidity standards: $\pm 1\%$ RH (0 to 90% RH); $\pm 2\%$ RH (90 to 100% RH).

When calibrated against salt solutions (ASTM E104-85): $\pm 2\%$ RH (0 to 90% RH); $\pm 3\%$ RH (90 to 100% RH).

Response time (90%) at +68°F (+20°C) in still air with sintered filter: 15 sec.

Temperature

Measurement range: -40° to +140°F (-40° to +60°C)

Accuracy at +68°F (+20°C): 0.36°F ($\pm 0.2^\circ\text{C}$)

Outputs

Analog outputs, selectable: 0 to 20mA, 0 to 1V

Analog outputs, scalable: 4 to 20mA, 0 to 5V

Operating temperature range:

-40° to +140°F (-40° to +60°C)

Storage temperate range:

-40° to +158°F (-40° to +70°C)

	Type	Order #
<i>Standard: Use with Centron</i>	Remote	HUM-VA1-REM
<i>Battery back-up</i>		HUM-BAT-BACK

Temperature/Humidity Transmitter for Stability

Application:

This is a 0 - 100% high performance temperature/humidity transmitter that is ideal for walk-in stability chambers. It is perfect for critical areas and applications where humidity and temperatures tend to fluctuate. The unit is fully temperature compensated and provides unsurpassed accuracy over the entire temperature range of -40° to +140°F (-40° to +60°C). The unit can operate in condensing environments, is resistant to harsh chemicals and contaminants, and has excellent long term stability. Maintenance can be performed on-site without disturbing transmitter operation. This one point calibration feature saves down time, reduces service costs, and ensures high accuracy operation.



Note: A battery back-up is recommended for every four sensors.

Specifications:

Dimensions: 145 mm W x 240mm H x 65mm D

Relative Humidity:

Measurement range: 0 to 100%

Accuracy (including nonlinearity and repeatability).

Maximum achievable when calibrated against high quality, certified humidity standards: ±1% RH (0 to 90% RH); ±2% RH (90 to 100% RH).

When calibrated against salt solutions (ASTM E104-85):

±2% RH (0 to 90% RH); ±3% RH (90 to 100% RH).

Response time (90%) at +68°F (+20°C) in still air with sintered filter: 15 sec.

Temperature:

Measurement range: -40° to +140°F (-40° to +60°C)

Accuracy at +68°F (+20°C): 0.36°F (±0.2°C)

Outputs:

Analog outputs, selectable: 0 to 20mA, 0 to 1V

Analog outputs, scalable: 4 to 20mA, 0 to 5V

Operating temperature range:

-40° to +140°F (-40° to +60°C)

Storage temperate range:

-40° to +158°F (-40° to +70°C).

	Type	Order #
<i>Standard: Use with Centron</i>	Wall Mount	HUM-VA1
<i>Battery back-up</i>		HUM-BAT-BACK

DC-Input Dual Channel Signal Isolator

Application:

Use the dual channel isolator to measure CO₂ and humidity levels in incubators with chart recorder outputs. This sensor is useful in eliminating ground loops, converting signal levels and providing signal drive. It completely isolates the input and output signals from each other and from ground. Input and output ranging is field selectable. The main application is converting 0 to 1 volt chart recorder outputs to a 0 to 5 volt signal that the Centron can use.

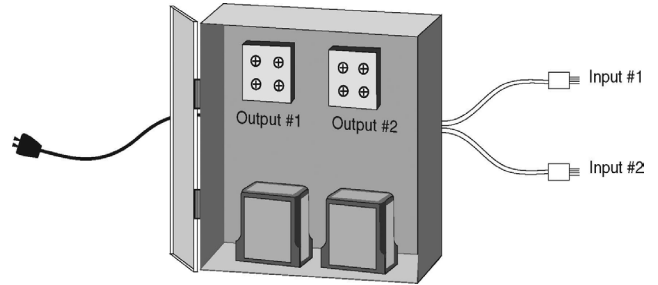

Incubators commonly have 0 to 1 volt signals for CO₂ and humidity.

Specifications:

Dimensions: 7.25" W x 8.25" H x 3.5" D

Isolation: 1500 VAC.

Linearity: 0.1% of full scale.

Drift: ±0.02%/ °C. typical, ±0.05% / °C maximum.

Ambient Operating Temperature: 0 to 55°C. (32° to 131° F.)

Output Loads:

Current: 600 ohms maximum.

Voltage: 500 ohms minimum (20 mA maximum).

Input:

Voltage: 0 to 1 V

Current: 0 to 20 mA.

Input Impedance:

Current: 10 ohms.

Voltage: 1 megohm.

Output:

Output Voltage: 0 to 5 V

Power Supply: 85 to 265 VDC/VAC 50 to 400 Hz.

Type	
Use with Centron	ISO-SIG-CON-LV

Humidity

Relative Humidity Sensor (Wall mounted)

Application:

For use in energy management control systems, clean rooms and computer rooms, industrial process control, environmental chambers and testing, and storage areas for humidity sensitive products. The wall mounted unit can be used in rooms subject to washdown.



Wall mounted

Specifications:

- Two-wire linear 4-20 mA.
- 4 wire linear 0-1 mA, 0-1, 0-5 & 0-10 VDC
- Humidity probe recovers from condensation, resists chemical vapors.
- Calibrated to NIST traceable standards
- **Standard Accuracy:** ±2% from 5-95% RH.
- **Low Cost Accuracy:** ±3% from 25-85% RH.

	Order # +2%	Order # +3%
<i>Standard: Use with Centron</i>	HUMIDITY-2PCT	HUMIDITY-3PCT

Space (Wall) Mount Relative Humidity Transmitter

Application:

Monitors ambient humidity for use in laboratories, clean rooms and server rooms. Specially designed enclosure provides enhanced airflow, thereby increasing sensor response time and virtually eliminating the potential of “self-heating” by transmitter electronics that can lead to decreased accuracy measurements.

Not recommended for use in stability or environmental chambers, outdoor applications, or other extreme environments. For use in these applications, refer to Part # HUM-VA1-REM.

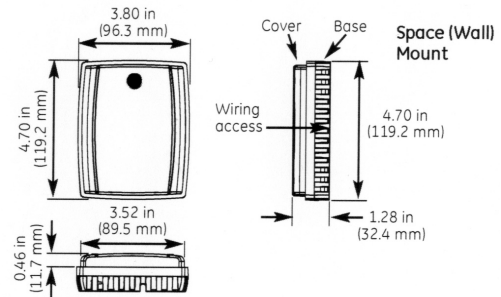

Specifications:

Operating Range: 0% to 99% RH (non-condensing)

Sensing Element: Capacitive polymer sensor

Accuracy at 71.6° F (22° C):

- ±2% version: ±2% 10 to 90% RH
- ±5% 0 to 10 % & 90-99 % RH

Long Term Stability: Less than 1% drift per year, typical

Temperature Effect:

$$\Delta \%RH = (0.0014 \times \%RH + 0.1325) \times T^{\circ}C - (0.0317 \times \%RH + 3.0876)$$

Signal Outputs: 4 to 20mA, 0 to 5V or 0 to 10V (user selectable).

Supply Voltage: 24 Volts DC.

Case: ABS Flame Retardant

Mounts on single gang box.

Rear wire entry.

Type	Order #
Relative Humidity Transmitter	HUM-ML2

Temperature-Light-Humidity Modules

Application:

Sensor Module 1 is a combination humidity, light, and temperature sensor designed for animal room monitoring applications where the area is subject to periodic washdown. The sensor module consists of a 2% humidity sensor combined with a Type 2 thermistor probe and a CDS photo cell light sensor for lights on vs. lights off monitoring.

Sensor Module 2 does not have the CDS photo cell light sensor.

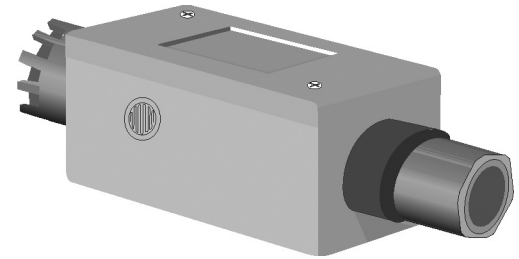

*Sensor Module 1
Light-Temperature-Humidity*

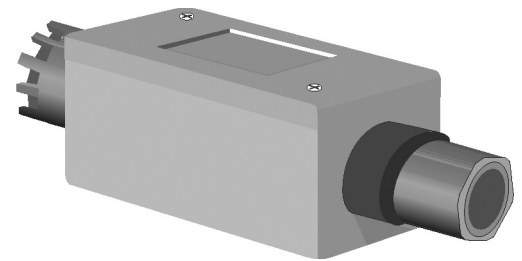

*Sensor Module 2
Temperature-Humidity*

Specifications:

Dimensions: 5" H x 2" W x 1.5"D

The Sensor Modules are designed to surface mount on the wall of a room with its lead wires protected by conduit. The sensors are housed in a gasketed, high impact polycarbonate case with the humidity sensor element protected by a sintered plastic cover to provide splash protection. Sensor Module 1 occupies three (3) system inputs per sensor module, and Sensor Module 2 occupies two inputs.

Humidity Sensor:

Accuracy: 2%
Range: 10-90% operating at 2%
0-100% calibration
Sensing Element:
Maintenance free polymer based humidity sensor.
Output: 4 to 20 mA

Temperature Sensor:

Range: -15 to +60 C. +5 to +140 F.
Probe Type =2
Sensor Element: Thermistor

Light Sensor:

Sensor Element: CDS Photo Cell

Type	Order #
Light-Temperature-Humidity Use with Centron	SENSOR MODULE-1
Temperature-Humidity Use with Centron	SENSOR MODULE-2

Manual Lighting Override Timer

Application:

For those facilities still controlling room lighting with a mechanical timer, the override timer can be used with the Centron monitor to insure that when someone enters an area and overrides the lighting control, that the lighting will return to its proper state automatically, even if you forget to reset.

The timer has a programmable digital display from 0 to 100 minutes. If you need to enter the room during a time when the lights are scheduled to be off, just enter the number of minutes that the override is to be in effect. You reset the timer when you leave. If you forget to reset the timer, the lights shut off when the time you originally programmed runs out.



Specifications:

Dimensions: 2.75" x 2.75"

- Microprocessor-based interval time switch.
- Switching 15 amp relay.
- Audible timeout alarm.
- Previous setting kept in memory to facilitate repeat operations.
- Large, easy to read LED display.
- Bit generator to 'dial-in' desired times.
- Manual Start/Stop and Reset buttons.
- Minimum 1 minute power hold-up.
- Several maximum time interval ranges available.

Type	Order #
Interval Countdown Timer	LIGHT TIMER

Oxygen

Oxygen Monitor

Application:

This sensor is used to protect people against low Oxygen levels in rooms where liquid nitrogen storage vessels are installed. The sensor is used in ‘freezer farms’, bone marrow labs, IVF labs, etc., anywhere low Oxygen levels might occur. It is also used where you have freezers with CO2 backup tanks in a confined space. A remote audible alarm, as well as a local alarm, can be triggered by the oxygen sensor. (See OSHA regulations for monitoring gases.)

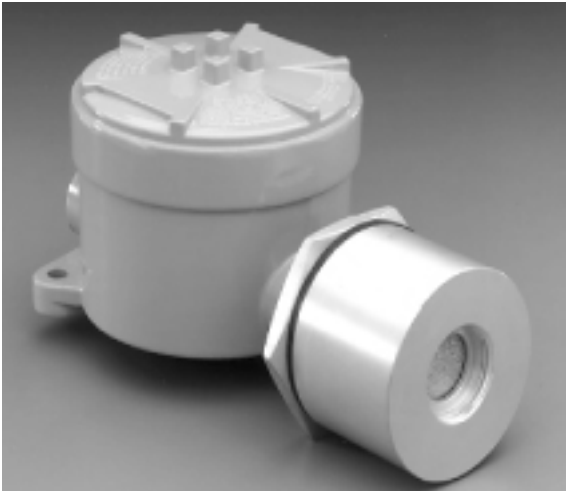

Specifications:

Dimensions: 8.5” long, 4.0” diam. x f4.2” deep

- Type:** Electrochemical - diffusion barrier type
- Range:** 0.1 - 25% Oxygen
- Sensor Life:** Two years in normal service
- Operating Temperature:** 5°F to 104°F (-15°C to 40°C)
- Humidity:** 5%RH to 99% RH
- Output Range:** 4 mA = 0%, 20 mA = 25% LEL
- Electrical Class:** Division 1, Class 1, Groups C & D
- Mounting:** Conduit
- Size:** 8.5” x 4” x 4.2”

Type	Order #
Oxygen Monitor	OXYGEN-2
Replacement sensor head for Oxygen-2	OXYGEN-2SH

Note: Replacement sensor head must be replaced every year.

Oxygen

Oxygen Sensor

Application:

This sensor uses Electrochemical gas sensor to detect the level of oxygen in room air. Typical applications are refrigeration rooms and oxygen storage rooms. The sensor provides an analog output of 4-20 mA DC linear output.

Not to be used in a life safety application.

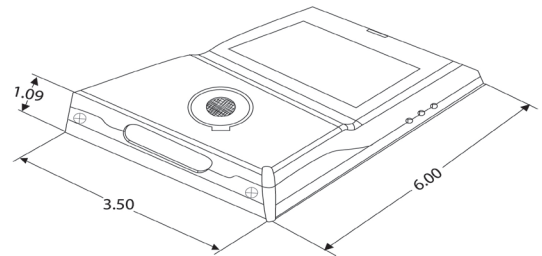

Specifications:

Dimensions: 6"h x 3.5"w

Factory Set Range: O₂, 0 to 25%

Accuracy: ± 2.5% of reading

Repeatability: ± 1% of reading

Input Power: 24 Volts DC

Enclosure Materials: Polycarbonate / ABS blend
Fire Retardant

Temperature: -20° C to 40° C

Humidity: Continuous 15 to 90% RH, non-condensing

Intermittent 0 to 99% RH, non-condensing

Pressure: Atmospheric ± 10%

Response Time: Less than 60 seconds for 90% of step change

Sensor Type: Electrochemical

Sensor Life: Typical 2 to 3 years

Output Signal: Analog, 4-20 mA

Mounting: Screw mounts to a standard 2" x 4" electrical junction box.

Type	Order #
Oxygen Sensor	.OXYGEN - ROOM

Single Phase Power Line Monitor

Application:

This transducer is used to monitor the 115V or 220 VAC single phase voltage being supplied to critical equipment. It comes with a standard wall plug for easy installation. It is designed to be plugged into the same duplex outlet used by the equipment.
NOTE: This sensor is not designed to alarm if power is removed because the equipment is unplugged or turned off by its ON/OFF switch.

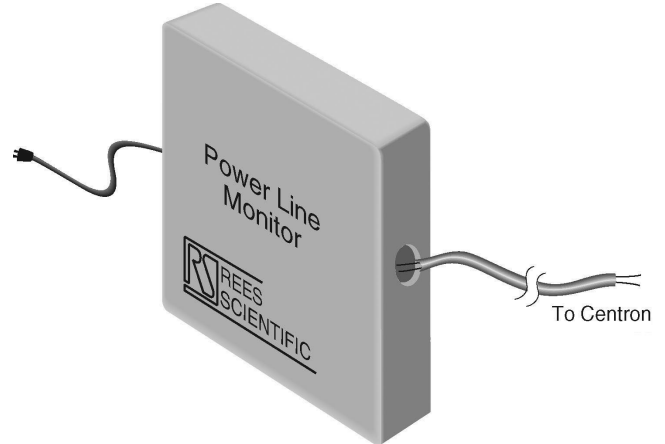

Specifications:

Dimensions: 5.375" H x 5.375" W x 2.125" D

Input: 115 or 220 VAC single phase - field selectable.

Output: 0-5 VDC proportional to input voltage.

Type	Order #
Standard: Use with Centron	PLM-115

3 Phase 220/440 Power Line Monitor

Application:

This solid state unit continuously monitors three phase lines for phase loss, low voltage, phase reversal, and phase unbalance. The output relay is energized under normal conditions, and de-energized while at fault. The unit automatically resets when the fault is corrected. This monitor can be used on WYE or DELTA systems since no neutral is required.

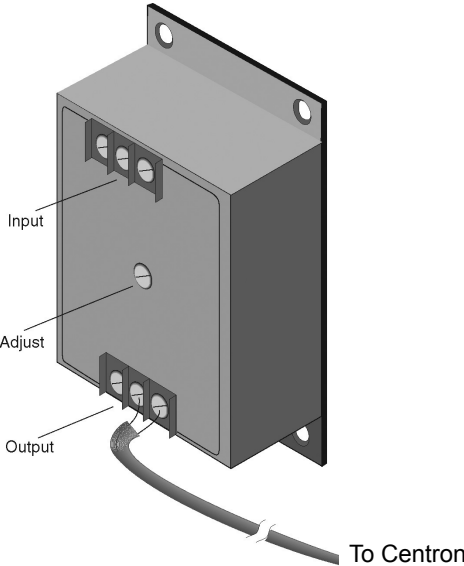

Specifications:

mensions: 3.88" W x 6" H x 2" D

Input: 60 cycle, 160VAC to 240VAC adjustable.
Output: Single pole double throw relay.

Input: 60 cycle, 380ACV to 480VAC adjustable.
Output: Single pole double throw relay.

Type	Order #
Standard: Use with Centron	PLM-220
Standard: Use with Centron	PLM-440

Large Diaphragm Pressure Switch

Application:

The PSSW-DUCT is an economical and reliable solution for monitoring airflow into animal rooms. Installed in the supply duct of each animal room, this SWITCH sensor has a field adjustable set point. The PSSW-DUCT, with an operating range measured in inches of water column, is available in five different ranges.

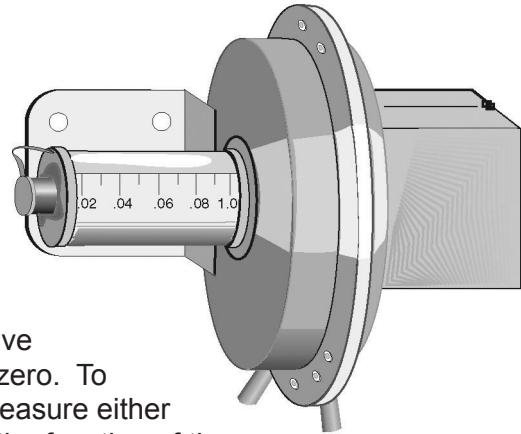

WARNING: The PSTR-DUCT only reads positive pressure differences. It does not go less than zero. To detect reversals in pressure, or to be able to measure either positive or negative pressure, depending upon the function of the room, use the Negative to Positive Differential Pressure Transmitter.

Specifications:

Dimensions: 7.75" diam. x 6.5" deep

- Diaphragm, 7.75", with visual set point adjustment. 1% repetitive accuracy.
- Temperature limits: -30° F. (34°C.) for dry air or gas to 110° F., (43° C.)
- Maximum pressure surge: 25 psig.
- Rated pressure: 10 psig.
- Pressure connections: .125" NPT.
- Electrical rating: 15 amps, 120-480 volts, 60 Hz. AC.
Resistive 1/8 HP @ 125 volts, 1/4 HP @ 250 volts, 60 Hz. AC.
- Wiring connections: 3 screw type, common, normally open and normally closed.
- Set point adjustment: Screw type with enclosed scale.
- Housing: 16 ga. steel, zinc plated, dichromate dipped for 200 hour salt spray test.
- Diaphragm: Silicone rubber with aluminum support plate.
- Calibration spring: Stainless steel.
- Weight: 4 lbs. 14 oz.
- Installation: Diaphragm vertical.

Standard: Use with Centron	Operating Ranges, Dead Bands and Ratings		
	Operating Range, Inches, W.C.	Approx. Dead Band	
		At Min. Set Point	At Max. Set Point
Order #			
PSSW-DUCT-1	0.05-0.25	0.04	0.05
PSSW-DUCT-2	0.20-1.0	0.04	0.06
PSSW-DUCT-3	1.0-3.0	0.06	0.08
PSSW-DUCT-4	2.0-6.0	0.07	0.25
PSSW-DUCT-5	3.0-12	0.11	0.30

Pressure Switch

Application:

Use the PSSW-2 to monitor CO₂ pressure to an incubator to determine when to change the tank. It is also used for general low pressure monitoring of compatible fluids.

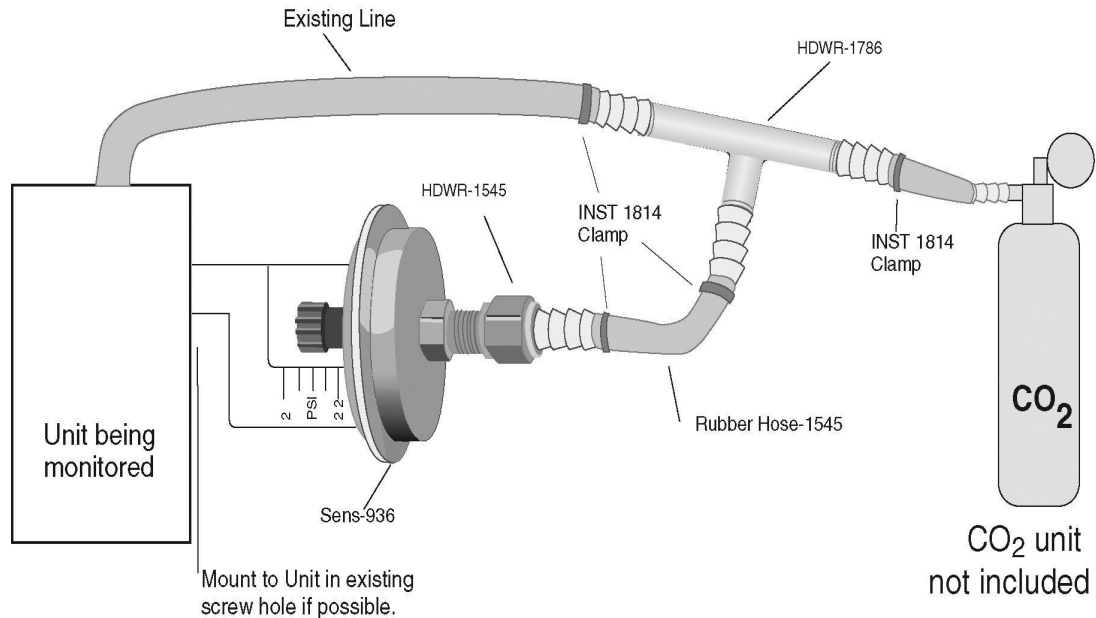

NOTE: When a PSSW-2 Sensor is ordered, all the parts listed above, with the exception of the CO₂ unit and the unit being monitored, are supplied.

Specifications:

Dimensions: 1.875" Diam., x 3.25" L

The PSSW-2 provides a switch closure output dependent upon a field adjustable set point. The range is 2 to 22 PSIG. The switch will activate when the pressure is greater than the set point, and deactivate when the pressure is below the set point. The switch is a single pole double throw configuration.

Switch: SPDT

Electrical connection: 1/4" quick connect, male.

Rating: 20 amp to 277 VAC @ 160° F for 100,000 cycles.

Range: 2 to 22 PSIG

Max. Operating Pressure: 75 PSIG

Operating Temperature: 0° C to 87° C., (32° F to 190° F.)

Pressure media: Non corrosive fluid compatible with 300 series stainless steel and BUNA-N.

Pressure connection: 1/4" hose barb - male

Type	Order #
Standard: Use with Centron	PSSW-2

Pressure

Differential Pressure Transmitter

Application:

The differential PSTR-DUCT is used to measure the pressure differential between two points, such as between a room and the hallway. It reads out in positive INCHES OF WATER. The PSTR-DUCT is available in several ranges, so it is necessary to know the pressure in inches of water column in order to specify the proper model. If you need to monitor negative pressure, or monitor for pressure reversals, use model # PSTR-DUCT-NP Negative to Positive Differential Pressure Transmitter.

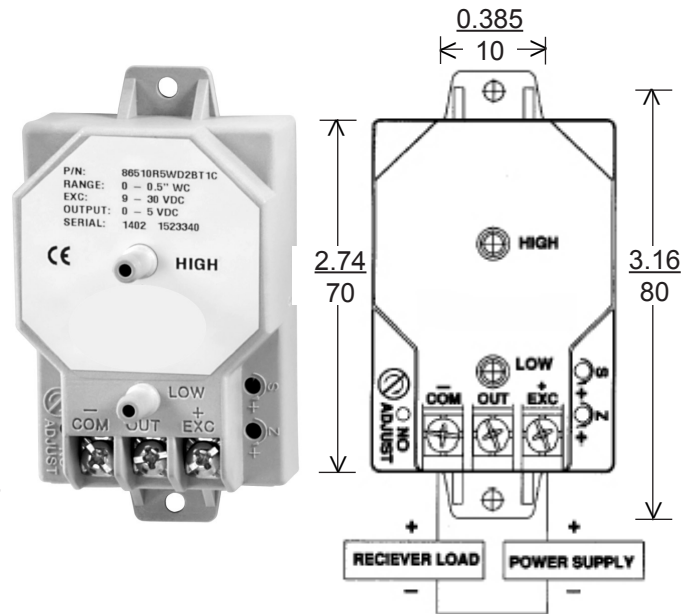

Specifications:

- Maximum Pressure: 10 PSI (0.7kg/cm²).
- Media Compatibility: Air or non-conducting gases.
- Power Supply: 9 - 30 VDC
- Output Signal: 4 to 20 mA DC, two wire loop-powered.
- Current consumption: 4 mA DC (unidirectional pressure ranges)
12 mA DC (bidirectional pressure ranges)
- Materials: Stainless steel diaphragm and insulated stainless steel electrode
- Weight: 3 ounces.
- Span & Zero Adjustments: Factory set to specified range. Externally accessible for fine adjustment. Non-interactive.
- Pressure Connection: 1/4" O.D. pressure fittings with 1/4" push-on tubing.
- Performance at 70° F:
- Zero Output: 4 mA DC (unidirectional); 12 mA DC (bidirectional)
- Accuracy (incl. linearity, hysteresis, repeatability): ± 1% of full span output.
- Operating Temperature: 0 °F to +150 °F (-18 °C to +65 °C)

Type	Order #
Differential Pressure Transmitter 0 to .25" - requires HUM-BAT-BACK	PSTR-DUCT-A
Differential Pressure Transmitter 0 to .5" WC- requires HUM-BAT-BACK	PSTR-DUCT-B
Battery Backup	HUM-BAT-BACK
Calibration of Differential Pressure Sensor using an NIST Traceable Manometer.	CAL -DIFF-PRES

Negative to Positive Differential Pressure Transmitter

Application:

This high accuracy differential PSTR-DUCT-NP is used to measure the pressure differential between two points, such as between a room and the hallway. It can read both positive and negative pressure so that you can use it to detect reversals in pressure. It reads out in *INCHES OF WATER*. The PSTR-DUCT-NP combines very low ranges with exceptional stability, reliability, and $\pm 0.5\%$ accuracy for the most demanding applications. This unit is designed to resist shock and vibration, practically eliminating drift. The unit is certified to NIST standards. It is available in several ranges, so it is necessary to know the pressure in inches of water column in order to specify the proper model.

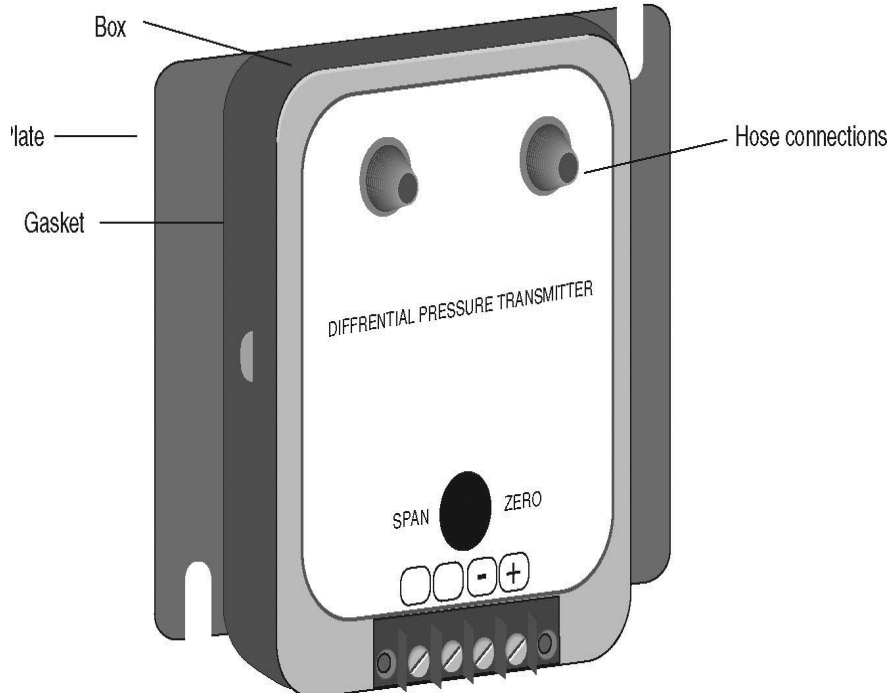

Specifications:

Dimensions: 4.2" H x 4.6" W x 1.825" D

- **Maximum Pressure:** 10 PSIG (0.7kg/cm²).
- **Media Compatibility:** Air & non-conductive, non-corrosive gases.
- **Power Supply:** 13 - 36 VDC unregulated.
- **Output Signal:** 4 to 20 mA DC, two wire.
- **Loop Resistance:** 0-1045 ohms, $V_{min} = 13V + [(0.022A)(RL)]$.
- **Current consumption:** 3.6 mA DC (min.).
- **Materials:** Ultra thin glass clad silicon diaphragm. Stainless steel housing (NEMA-2).
- **Weight:** 14 ounces.
- **Span & Zero Adjustments:** Factory set to specified range. Externally accessible for fine adjustment. Non-interactive.
- **Pressure Connection:** Barbed, stainless steel for 1/4" I.D. tubing.
- **Performance at 70° F:**
Zero Output: 4 mA DC; Full Span Output: 20 mA DC
Accuracy (incl. linearity, hysteresis, repeatability): $\pm 0.5\%$ of full span output.
Stability: $\pm 1\%$ of full span/year. Warm-up Time: 15 seconds.
- **Operating Temperature:** (10-95% Rh, non-condensing)
-20 to 160°F (2 to 57°C)
- **Storage:** -40 to 180°F
(-40 to 82°C)

	Order #	Range in Inches of Water
Standard: Use with Centron	PSTR-DUCT-NP	-.50 to +.50
Calibration of Differential Pressure Sensor using an NIST Traceable Manometer.	CAL-DIFF-PRES	

Application:

The Rotation sensor is used to detect the motion of platelet rotators.

An electrical pulse is generated every time the magnet that is mounted on the rotating equipment passes the Rotation sensor. If this pulsing electrical signal stops, the monitor goes into alarm.

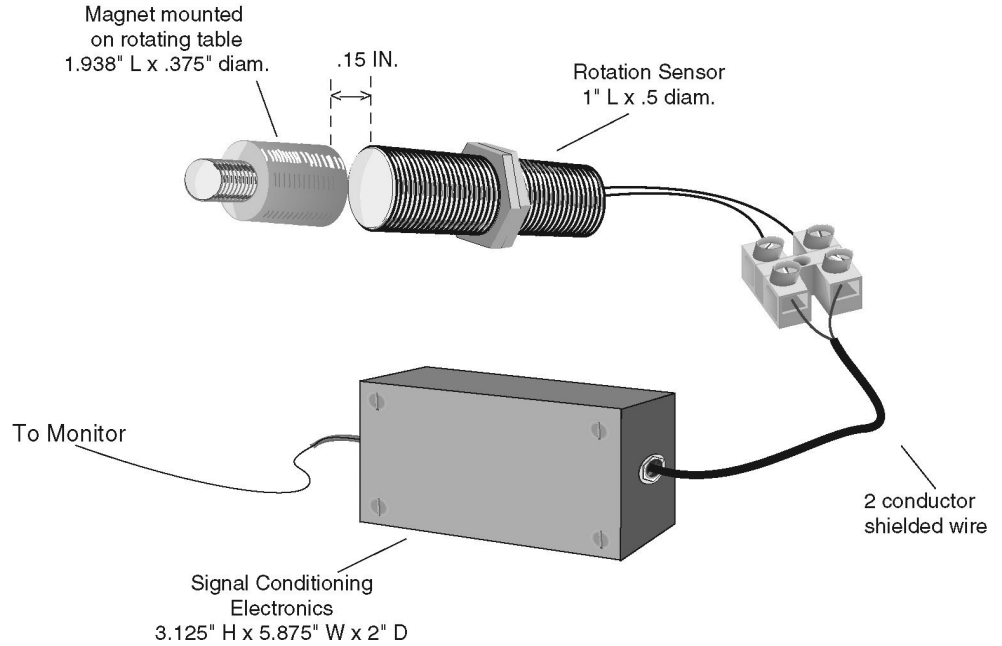

Specifications:

- Supply Voltage: 5 VDC @ 10mA
- Output Voltage: 5 VDC in alarm; 0 VDC in motion
- Min. Frequency: 1 pulse in 20 seconds
- Max. Displacement: .15 inches
- Programming: Program as switch input; alarm when high
- Alarm delay = 0 minutes
- The pluggable rotation sensor comes with a 3.5mm sensor plug on 25 feet of shielded wire.

Type	Order #
Standard: Use with Centron	ROTATE-1

Application:

The Shaker sensor is used to detect motion on shaker tables. The Shaker sensor translates a motion into an electrical signal that can be monitored by the Centron.

As long as the sensor continues to move, it generates a signal that keeps the monitor out of the alarm state.

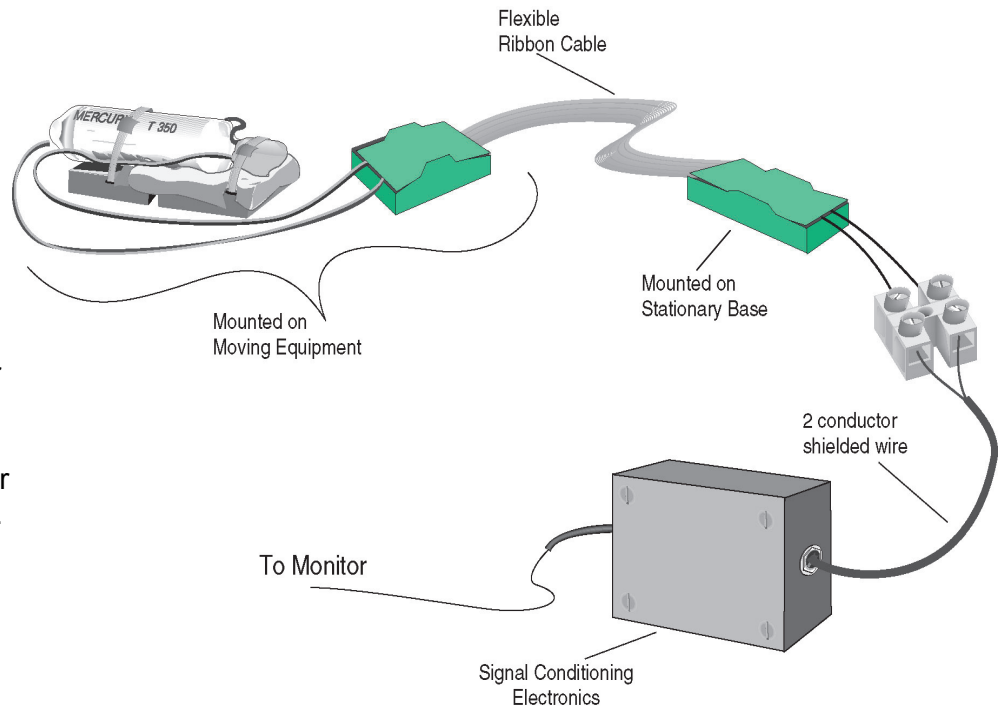

Specifications:

- Supply Voltage: 5 VDC @ 10 mA
- Output Voltage: 5 VDC in alarm, 0 VDC in motion
- Min Frequency: .5 Hz
- Min Displacement: .25 In
- Programming: Program as switch input; alarm when high.
- Alarm delay = .5 min.
- The pluggable shaker sensor comes with a 3.5mm sensor plug on 25 feet of shielded wire.

Type	Order #
Standard: Use with Centron	SHAKE-1

Surface Water Detector

Application:

Detect water in computer rooms, document storage areas, warehouses, bone marrow rooms, any place where water can cause damage and loss. Detect leaks, monitor sump pumps, cage wash rooms, and sprinkler systems. The sensor is designed to detect water, but it will not alarm due to condensation or high humidity.

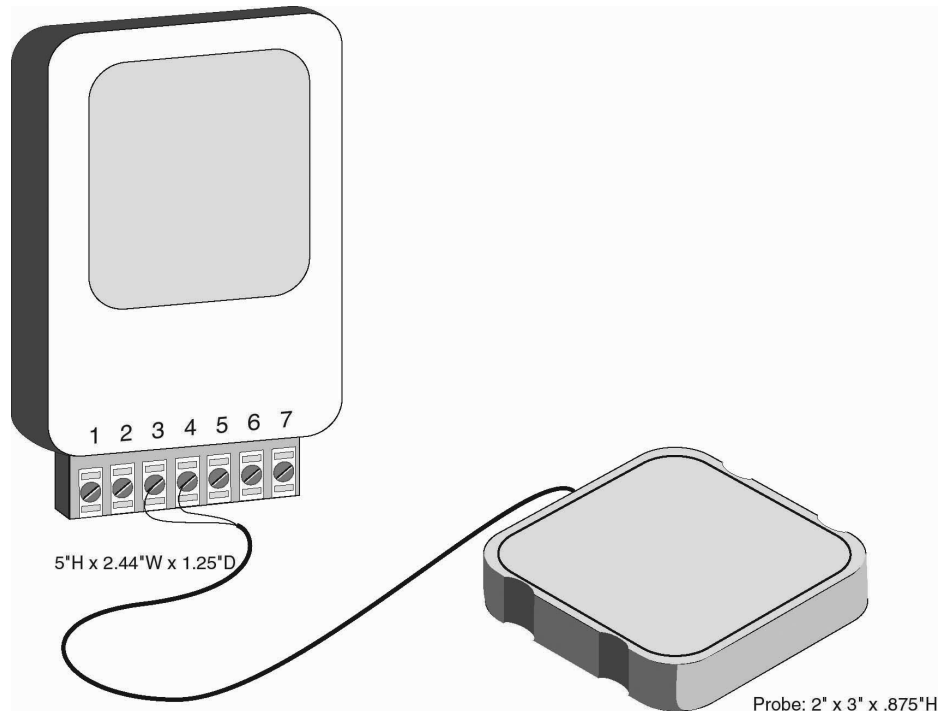

Specifications:

Each sensor can be connected to up to six (6) probes and can cover a distance of up to 100 feet from the wall mounted sensor.

Power requirement: 8-14 VDC.

Current draw resting state: 3.5 mA at 12 VDC.

Current draw alarm condition: 43 mA at 12 VDC.

Sensitivity: Will not alarm due to high humidity or condensation.

Each probe has 2 contacts. A film of water, forming a bridge between them, is needed for an alarm condition.

Operating temperature: Control unit - 32° to 140°F., (0° to 60° C.)

Probe - 32° to 140° F., (0° to 60° C.)

Relay rating: 1 Amp at 24 VAC, resistive.

Relay specifications: 1 Amp at 30 VDC, resistive.

Each sensor comes with one probe.

Type	Order #
Standard: Use with Centron	SWD-1
Additional Probes	SWPR

Light Sensor

Application:

The PHOTO-P1 is designed for use in applications where it is only necessary to know if the lights are on or off. Its principal application is in animal rooms and plant growth chambers.

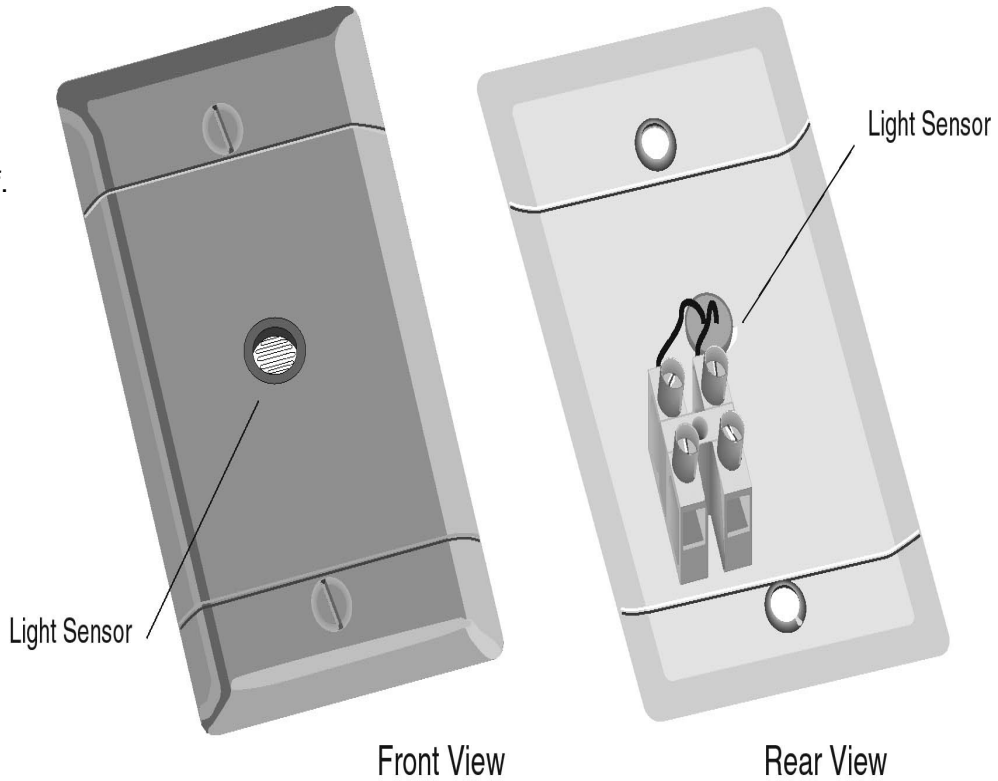

Specifications:

Dimensions: 2.75" W x 4.5" H

CDS photo cell mounted on a stainless steel plate which can be mounted in a single gang box. It is epoxy sealed and water resistant.

Type	Order #
CDS	PHOTO-P1

Temperature

Ambient Temperature Sensor

Application

The TPT-2-Ambient sensor is designed specifically to monitor ambient room air temperature. The unit is a stainless steel plate with the sensor protruding through the face of the plate. The junction of the plate and the sensor is gasketed for water resistance. This sensor is useful in HVAC applications to monitor and/or control room temperature; i.e. computer rooms, animal rooms, file storage rooms, packaging rooms, with bench testing, freezer rooms, etc.

Monitoring the ambient temperature in a room full of freezers gives you warning if the room air handler goes down, preventing compressor overload.

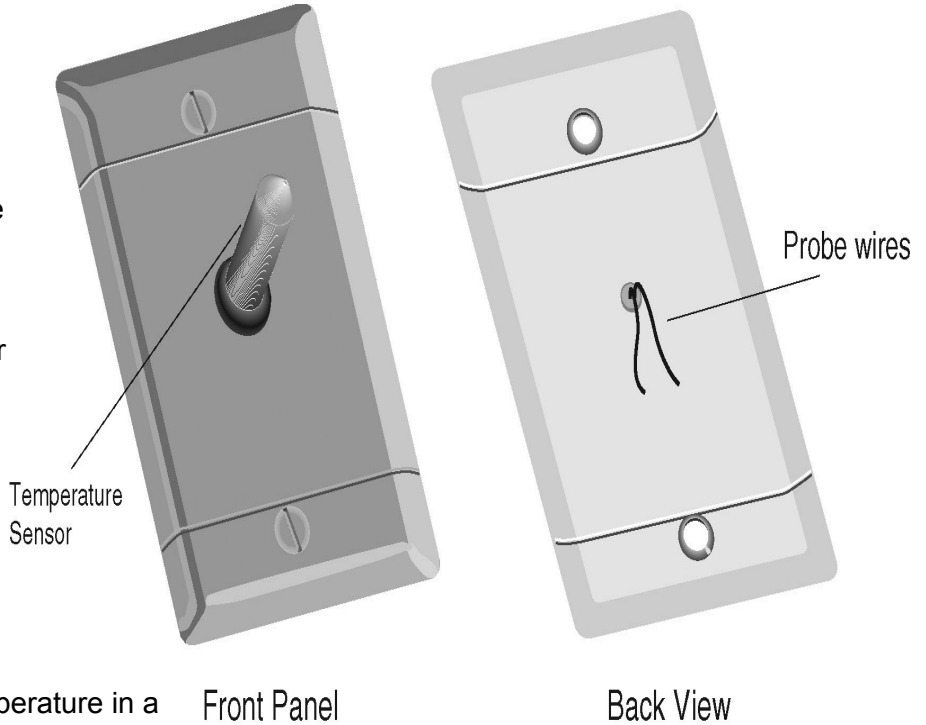

Specifications:

Dimensions: 2.75" W x 4.5" H

Temperature sensor provides great sensitivity and fast response time.
Connections are sealed against moisture.
Can be installed onto a single gang box.

Thermistor Temperature Range			
PROBE "TYPE"	RESISTER	RANGE (°C)	RANGE (°F)
2	4990 ohm	-15 to +60	+5 to +140

	Order #
Ambient Air Sensor with Wall Plate Temperature Probe	TPT-2-A
3 Point Calibration per Input. Minimum of 5 Points Required. Must be Completed at Time of Validation.	CAL-3POINT
Fire and Ice Test per Input. Minimum of 5 Points Required. Must be Completed at Time of Validation.	CAL-FIRE-ICE

Cryogenic Thermistor Probe

Application:

This device constitutes an excellent alternative to our thermocouple amplifier for the monitoring levels of liquid nitrogen freezers and Dewars. The Cryo-6 probe is a good level sensor and is useful for determining when liquid nitrogen tanks need to be refilled. When the liquid nitrogen goes below the probe level, the temperature above increases and sets off an alarm. It's time to refill the tank. Disconnectable probes are available for situations where equipment is routinely moved or switched around. A programming change is all that is required when probes are moved to new equipment.

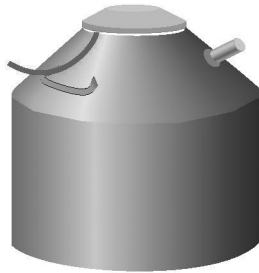

Dewar LN₂ Storage Container

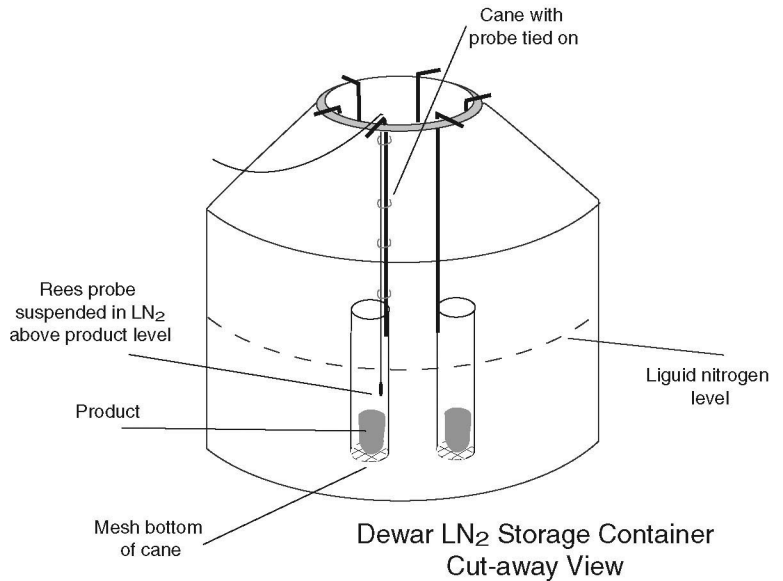

Dewar LN₂ Storage Container
Cut-away View

Specifications:

Dimensions: Probe: 2.75" L x .25 diam.

- This probe is similar to our standard thermistor probe in physical structure, but it is designed with a -125 to -200° C. temperature range. These probes are stable and are accurate to within 1° C. once calibrated at the liquid nitrogen temperature of -196° C. With deviation from the calibrated temperature their temperature accuracy decreases. Approximate errors are ±2° at ten degrees from the calibrated point, and ±6° at 60° from the calibrated point.
- Pull-up resistor value at remote panel is 3.01K for standard, non-disconnectable probes.
- The Cryo-6 probe can be used with the Centron.
- The disconnectable probe has 15' of wire with a 1/4" plug, and a wall plate with jack .
- The 1/4" disconnectable probe requires a 100K pullup resistor between sense and +5 volts at the remote panel.

Type	Temperature Ranges		Order #
	(Deg. C.)	(Deg. F.)	
Standard: Use with Centron	-200 to -125	-328 to -193	CRYO-6
Standard: Use with Centron	-200 to -125	-328 to -193	P-CRYO-6
Fire and Ice Test per Input. Minimum of 5 Points Required. Must be Completed at Time of Validation.			CAL-FIRE-ICE

Thermistor Probes

Application:

The thermistor is a high precision temperature sensitive resistor made to read in a preset temperature range with 1 degree accuracy (0.2 degree on 12 bit systems). The TPT series is most commonly used for ambient temperature readings in animal rooms, refrigerators, freezers, incubators, growth chambers, and greenhouses. Disconnectable probes are offered for the Centron so that equipment can easily be moved or switched. A programming change is all that is required to move probes.

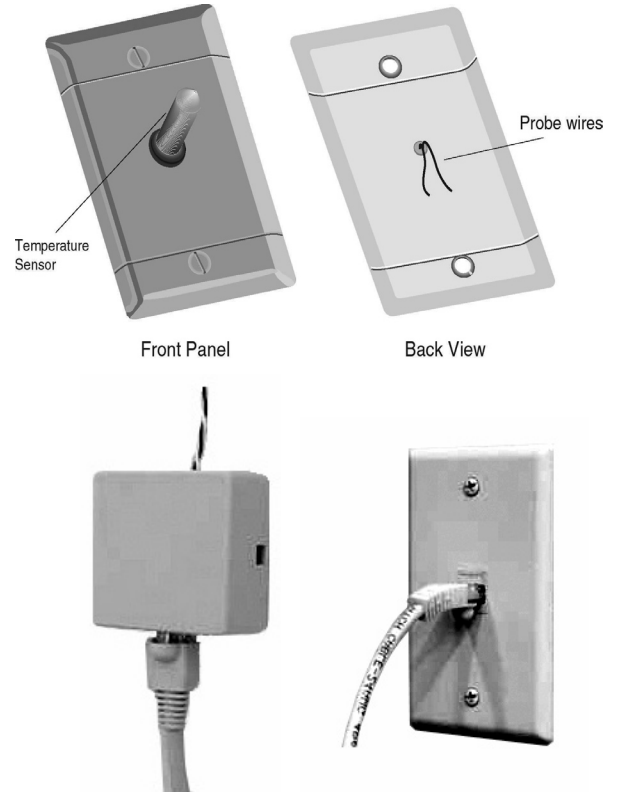

Specifications:

Sensor Accuracy: Mfr. Specified resistance curve within 0.2 degrees C from 0-70 degrees C.
Resolution (12-Bit): 0.1 degrees C

NOTE: You will realize a system accuracy of +/- 1.0 degrees C with the 8-Bit System due to the system resolution.

Standard Order #	Standard Probe Pull-up Resistor at Remote Panel	Thermistor Temperature Ranges		C O L O R	Pluggable Order #
		(Deg. C.)	(Deg. F.)		
TPT1	1000 ohm	+40 to +105	+104 to +221	ORG	P-TPT1
TPT2	4990 ohm	-15 to + 60	+5 to +140	RED	P-TPT2
TPT3	30100 ohm	-50 to +10	-58 to + 50	YEL	P-TPT3
TPT4	100000 ohm	-90 to -10	-130 to +14	BLUE	P-TPT4
TPT-2-HD	4990 ohm	-15 to + 60	+5 to +140	RED	N/A
3 Point Calibration per Input. Minimum of 5 Points Required. Must be Completed at Time of Validation.			CAL-3POINT		
Fire and Ice Test per Input. Minimum of 5 Points Required. Must be Completed at Time of Validation.			CAL-FIRE-ICE		

Temperature Stabilization (Equilization) Kit - Glycol

Application:

The glycol kit is used to suspend a probe, located in a refrigerator or freezer, in a solution of antifreeze (provided by the user) to cause temperature readings to reflect product temperature rather than instantaneous box temperature.

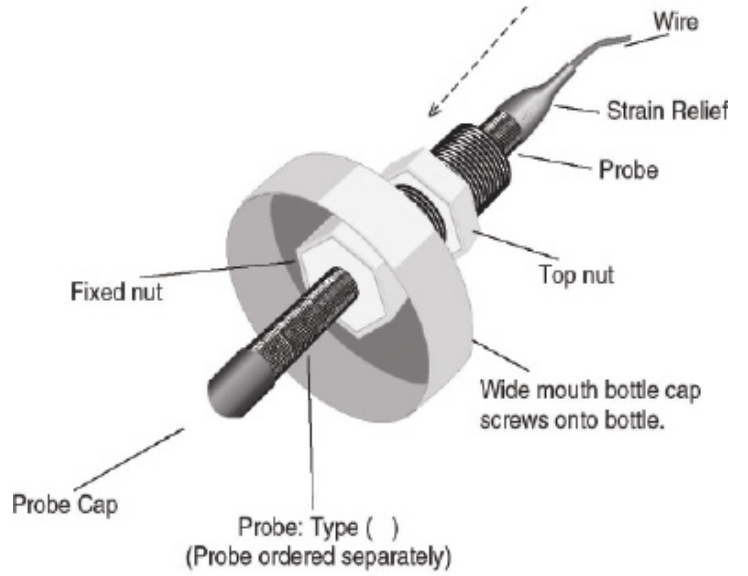

Specifications:

250ml plastic bottle

Dimensions: 2.25" Diam. x 5.125"H

Type	Order #
Glycol Bottle and cap assembly, Probe not included	GLYCOL-KIT

Temperature Stabilization (Equilization) Kit - Sand

Application:

The temperature stabilization kit is used to suspend a probe, located in a refrigerator or freezer, in a sealable container filled with sand. Using the kit enables the probe to get temperature readings that reflect product temperature rather than instantaneous box air temperature. Sand is ecologically friendly, with no disposal problems.

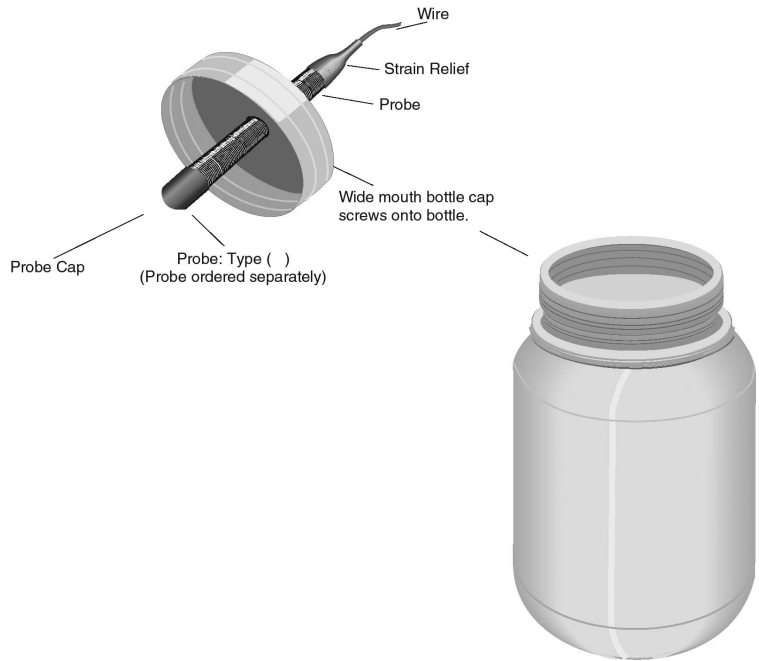

Note: Blood Bankers may want to refer to their compliance manuals before purchase.

Specifications:

Dimensions: 2.25" Diam. x 3.25"H

- 1 plastic bottle filled with sand.
- 1 lid, predrilled with a hole for your probe.

Type	Order #
Bottle and cap assembly, including sand.	TEMP-KIT
Probe not included.	

RTD Temperature Sensor

Application:

When performance and accuracy are a must, Rees Scientific can offer our RTD temperature sensors. These RTD sensors are available in a variety of temperature ranges, all designed to meet your monitoring needs. Rees Scientific can also offer certified RTDs. Certified RTD's include a calibration certificate to verify that the sensor was factory calibrated at five points over the operation range of the sensors. Rees Scientific offers loop calibration services to accompany these certified sensors (must be re-done each year).

Specifications:

Ranges: -200 to +100°C (See Table)

Output: 4 to 20 mA

Sensor: 1K Platinum RTD

Supply Voltage: 7-35 VDC 24 VCD Nominal

Tolerance in Deg. C.

Single Point $\pm(0.5 + 0.005 T)$; T = Absolute value of Temp in °C

Accuracy: +/- 0.1% of span

6 ft. Sensor Cable

Type	Range	Order #
RTD Probe and Transmitter	0 to +100C	RTD 0+100
RTD Probe and Transmitter (incl. 5 pt. cert.)	0 to +100C	RTD 0+100-CRT
RTD Probe and Transmitter	+10 to +70C	RTD+10+70
RTD Probe and Transmitter (incl. 5 pt. cert.)	+10 to +70C	RTD+10+70-CRT
RTD Probe and Transmitter	-100 to +30C	RTD-100+30
RTD Probe and Transmitter (incl. 5 pt. cert.)	-100 to +30C	RTD-100+30-CRT
RTD Probe and Transmitter	-20 to +30C	RTD-20+30
RTD Probe and Transmitter (incl. 5 pt. cert.)	-20 to +30C	RTD-20+30-CRT
RTD Probe and Transmitter	-200 to +60C	RTD-200+60
RTD Probe and Transmitter (incl. 5 pt. cert.)	-200 to +60C	RTD-200+60-CRT
RTD Probe and Transmitter	-50 to +50C	RTD-50+50
RTD Probe and Transmitter (incl. 5 pt. cert.)	-50 to +50C	RTD-50+50-CRT
5 Point Input Calibration to Ensure Overall System Accuracy Using a Certified 4 to 20 mA Sensor. Minimum of 5 Points Required. Must be Completed at Time of Validation.		CAL-LOOP

Temperature

Thermocouple Amplifier

Application:

Thermocouples can be used over a wide range of temperatures. When the temperature to be measured falls outside the range of a standard TPT thermistor probe (< -80° C. or > 105° C.), (< -112° F. or > 157° F.) the thermocouple should be used. It is most commonly used when monitoring liquid nitrogen freezers.

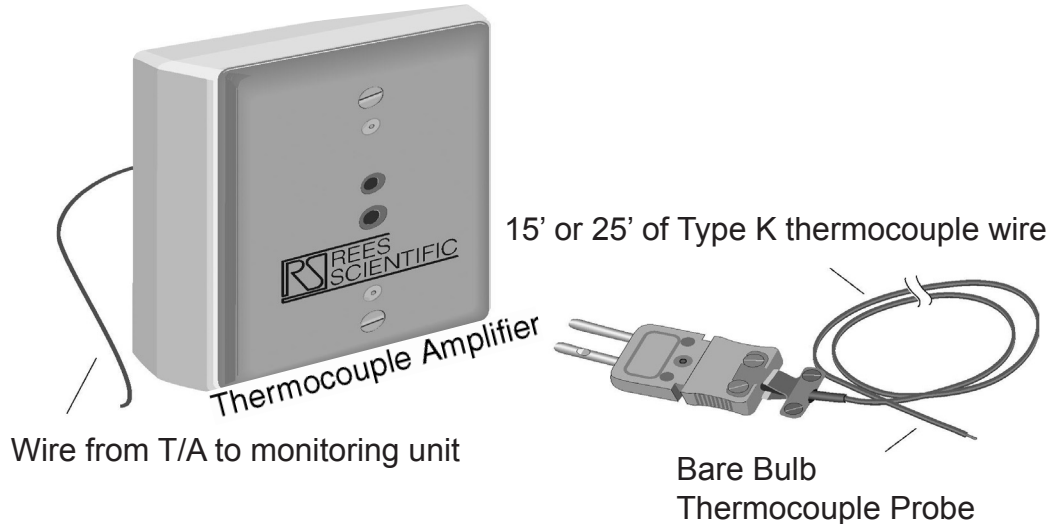

Specifications:

Dimensions: 3.125" x 4.75", includes enclosure.

The thermocouple amplifier will mount in a single gang electrical box or surface mount in the provided enclosure. It comes with industry standard quick disconnect with 15 or 25 feet of wire. The thermocouple is a temperature measurement device that produces a very small voltage in proportion to the temperature differential across the sensor. The thermocouple amplifier converts this small voltage into a signal that can be used by the Rees Monitors. The accuracy above -70° C. is ±1.5°; from -270° C to -70° C the accuracy is ±3°.

Thermocouple amplifiers come with Type K thermocouple wire w/plug, in either 15' or 25' lengths.

Use the standard thermocouple amplifier with the Centron.

Order # (w/15' wire)	Order # (w/25' wire)	Temperature Ranges	
TA - 16-15	TA - 16-25	-270 to + 50° C	-454 to 122° F.
TA - 17-15	TA - 17-25	0 to 250° C	32 to 482° F.
TA - 18-15	TA - 18-25	200 to 450° C	392 to 842° F.
TA - 19-15	TA - 19-25	400 to 650° C	752 to 1202° F.
TA - 20-15	TA - 20-25	600 to 850° C	1112 to 1562° F.
TA - 21-15	TA - 21-25	800 to 1050° C	1472 to 2102° F.
TA - 22-15	TA - 22-25	1000 to 1250° C	1832 to 2282° F.

Gas

Combustible Gas Sensor

Application:

Monitors ambient air for concentrations of combustible gas in the range of 0-100% of the lower explosive limit.



Features:

- ▣ CSA and UL Approved: Class I, Division 1, Groups B, C, & D
- ▣ Plug-in field-replaceable transmitter and sensor
- ▣ Integral sensor fault diagnostics
- ▣ Long sensor life expectancy
- ▣ High resistance to poisons such as sulfides, chlorides, silicon-based contaminants etc.
- ▣ Low power consumption (less than 3.5 watts versus 8+ watts on competitive brands)

Specifications:

Dimensions: 7.25" H x 6.125" Diam.

- Sensor Type:** Matched-pair catalytic bead
- Measurement Range:** 0-100% LEL (lower explosive limit)
Combustible Gas
- Accuracy/Repeatability:** ±3% 0-50% LEL
±5% 50-100% LEL
- Response/Clearing Time:** T50 <10 seconds
T90 <30 seconds
- Zero Drift:** <5% per year
- Operating Temp. Range:** -40°F to +167°F; -40°C to +75°C
- Operating Hum. Range:** 0-99% RH non-condensing
- Outputs:** Linear 4-20 mA DC
- Input Voltage:** 11.5-28 VDC
- Power Consumption:** 2.1 watts @ 24 VDC
- Electrical Classification:** Explosion proof Class I, Division 1,
Groups B, C, D
- Safety Approvals:** CSA and UL Approved

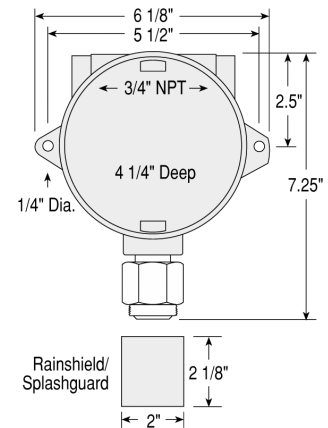

Type	Order #
Standard: Use with Centron	CG-Sensor