

Contents

Air Velocity.....	3
Ammonia Gas in Air Sensor.....	4
Carbon Dioxide Monitor	5
Flow Transmitter.....	6
Temperature/Humidity Transmitter.....	7
Temperature/Humidity Transmitter for Stability	8
DC-Input Single Channel Signal Isolator.....	9
Relative Humidity Sensor (Wall Mounted)	10
Relative Humidity Sensor (Duct Mounted).....	11
High Temperature Humidity Sensor	12
Space (Wall) Mount Relative Humidity Transmitter.....	13
Temperature-Light-Humidity Modules.....	14
Temperature-Humidity Modules	15
Manual Lighting Override Timer	16
Oxygen Sensor	17
Single Phase Power Line Monitor	18
3 Phase 220/440 Power Line Monitor	19
Large Diaphragm Pressure Switch	20
Pressure Switch.....	21
Differential Pressure Transmitter	22
Negative to Positive Differential Pressure Transmitter	23
Pressure Transmitter	24
Rotation Sensor.....	25
Shaker Sensor.....	26
Surface Water Detector	27
Light Sensor.....	28
Ambient Temperature Sensor	29
Cryogenic Thermistor Probe	30
Thermistor Probes	31

Temperature Block.....	32
Temperature Stabilization (Equalization) Kit – Glycol	33
Temperature Stabilization (Equalization) – Kit Sand	34
Z3 RTD Temperature Sensor	35
RTD Temperature Sensor	36
Thermocouple – Freezers and Cryo Tanks.....	37
Combustible Gas Sensor	38
Particle Counter Sensor	39

Air Velocity

This sensor is ideal for use in animal facilities. It allows you to read the number of 'room air changes per hour' directly, or to read air changes in 'feet per minute'. Other applications include supply and exhaust fan tracking, industrial hygiene and clean room systems, and manufacturing or process control.



Specifications:

Measuring values

Working Range *0...10m/s (0...2000ft/min)

*0...15m/s (0...3000ft/min)

*0... 20m/s (0...4000ft/min)

*Range selectable by jumper

Output 0 - 10 V

4 - 20 mA RL < 450 Ω

Accuracy at 20°C (68°F), 45 % RH and 1013hPa

0...10m/s (0...2000ft/min) ± (0.2m/s / 39.4ft/min + 3 % of m. v.)

0...15m/s (0...3000ft/min) ± (0.2m/s / 39.4ft/min + 3 % of m. v.)

0...20m/s (0...4000ft/min) ± (0.2m/s / 39.4ft/min+ 3 % of m. v.)

Power supply 24V DC ± 20 %

Current consumption

DC supply max. 90 mA

Angular dependence < 3 % of measurement at | Δα | < 10°

Cable gland M16x1.5 cable Ø 4.5 - 10 mm (0.18 - 0.39")

Electrical connection screw terminals max. 1.5 mm² (AWG 16)

Temperature range working temperature probe -25...50°C (-13...122°F)

working temperature electronic -10...50°C (14...122°F)

storage temperature -30...60°C (-22...140°F)

Type	US Part #
Standard: Use with Centron	AIR-VEL-1
Calibration of Air Velocity Sensor. Customer to Supply Calibration Instrument	CAL-AIRVEL

All specifications are subject to change without notice.

Ammonia Gas in Air Sensor

As more and more facilities install ventilated cage rack systems for animal research, new monitoring concerns often arise. One of the issues is room ammonia levels. The common goal of facilities using ventilated cage racks is to cut down on the number of bedding changes. By circulating cool, clean air into the individual cages, technicians feel they can significantly extend the life of the bedding, sometimes up to 2 to 3 weeks. By extending bedding life, institutions can reduce labor and materials costs.

Most of the current rack systems on the market circulate air from within the room through the racks and cages. The exhaust air is then blown from the rack into the room.

The facilities HVAC system will then circulate clean air into the room. When the bedding life is extended, you can expect an increase in ammonia levels. By placing an ammonia sensor in the room or duct, you can make a better determination of when the cages need to be changed.

Specifications:

- Sensor Type:** Electromechanical
- Range:** 0-50 PPM **Resolution:** 0.5 PPM
- Response time:** 90% ,30 sec. **Sensor Life:** 1 year
- Operating Temperature:** 14° to +113°F. (-10° to + 45° C)
- Relative Humidity:** 20 - 90%
- Weight:** 2.1 lb.
- Calibration frequency:** 90 days recommended
- Electrical data:**
 - Loop type: 3 wire
 - Loop resistance: 800 Ohms at 28 VDC Input
 - voltage VDC: 14-30
 - Input current: 40mA
 - Input power (max): 14 W
 - Signal output - Normal: 4 - 20mA DC linear
 - Signal output - Trouble: 0mA
- Operating pressure:** +10% (variation from ambient)
- Housing:** Explosion proof (NEMA 7)
- Warranty:** 1 year
- Dimensions:** 8.8" x 4.0" x 4.2"

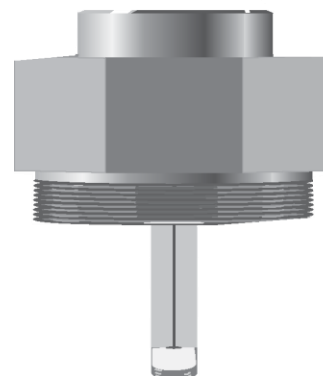
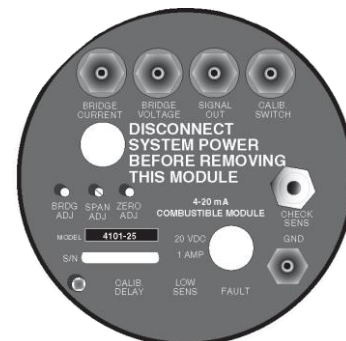

Type	US Part #
Ammonia gas in air sensor	AMMONIA-1

All specifications are subject to change without notice.

Carbon Dioxide Monitor

Carbon Dioxide transmitters are designed to measure CO₂ in harsh environments such as incubators and greenhouses. The materials are corrosion resistant and the housing is dust and water resistant to NEMA 4/IP65 standards. This sensor has outstanding stability over both time and temperature. Longer time between calibration intervals saves both time and money.

The sensor has a measurement range of 0-20% CO₂. The transmitter probes are interchangeable and they facilitate easy field maintenance. Probes can be returned for recalibration.

Note: A battery back-up is recommended for every four sensors.



Specifications:

Measurement range: 0 - 20%

Accuracy: at 77° F (+25° C) < ±[0.3% CO₂ + 2% of reading]

Stability: <±5 %FS/2 years

Temperature dependence, typical: -0.3 % of reading / °C

Pressure dependence (typ.): +0.15% of readings/hPa

Response time (63%): 20 seconds

Analog output signals: 4 to 20 mA

Power supply: 24 VDC

Warm-up time: < 15 minutes

Operating temperature range: -4° to +140°F (-20° to +60° C)

Storage temperature range: -22° to +158°F (-30° to +70° C)

Operating humidity range: 0 to 100% RH non-condensing

Type	US Part #
Complete CO ₂ Sensor	CO2-MON-RM
Calibration of CO ₂ sensor using an NIST traceable instrument.	CAL-CO2

All specifications are subject to change without notice.

Flow Transmitter

Measure the flow of a liquid in pipes to an animal room, or any location.

*Flow transmitter require pipe fittings which are not supplied.
See Flow Transmitter fittings.*

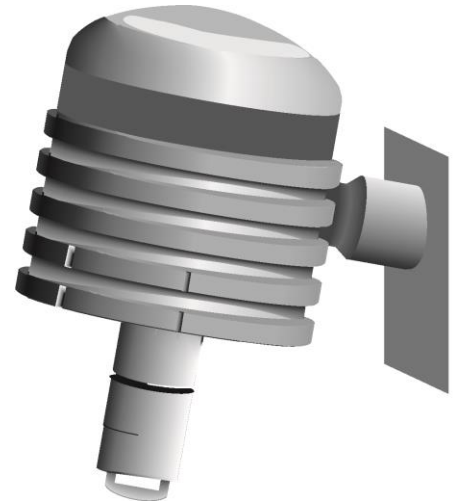

Specifications:

Housing Material: Polypro

Bearing Material: at 95% Alumina Ceramic

Pipe Size: 1/2" to 4"

Sensor O.D. : 1.05"

Sensor Length: 3.50"

Output: 4-20mA

Paddlewheel Sensor:

Range: ± 1.0 FPS to 12 FPS Std. to 20 FPS opt.

Linearity: $\pm 1\%$ over full range

Repeatability: $\pm 1/2\%$ over full range

Accuracy: $\pm 1\%$ over full range

Pressure Rating: 200 psig at 25°C

Temperature Rating: 212° F at 50 PSIG (requires metal fitting)
180° F at 25PSIG (CPVC fitting)

Max % Solids: 1% of fluid volume

Dimensions: 5.75"H x 6.375" Diam.

Type	US Part #
Standard: Use with Centron	FLOW-1

All specifications are subject to change without notice.

Temperature/Humidity Transmitter

This temperature/humidity transmitter is used in reach-in stability chambers and incubators. Its small sensor head responds quickly to surrounding temperature changes.



Specifications:

Relative Humidity

Measurement range: 0 to 100%

Accuracy: ± 1.0 % RH

Response time: 10 s (63 % change)

Temperature

Measurement range: -40° to $+140^{\circ}$ F (-40° to $+85^{\circ}$ C)

Accuracy: $\pm 0.1^{\circ}$ C

Analog outputs: 4 to 20mA

Operating temperature range of transmitter: -40° to $+140^{\circ}$ F (-40° to $+60^{\circ}$ C)

Dimensions: 129mm W x 72mm H x 45mm D, excluding probes

Sensor requires 24VDC Power (Current Draw < 100 mA)

Type	US Part #
Standard: Use with Centron (Remote)	HUM-RT1-REM
Battery back-up	HUM-BAT-BACK

All specifications are subject to change without notice.

Temperature/Humidity Transmitter for Stability

This is a 0 - 100% high performance temperature/ humidity transmitter that is ideal for walk-in stability chambers. It is perfect for critical areas and applications where humidity and temperatures tend to fluctuate. The unit is fully temperature compensated and provides unsurpassed accuracy over the entire temperature range of -40° to +140°F (-40° to +60°C). The unit can operate in condensing environments, is resistant to harsh chemicals and contaminants, and has excellent long term stability. Maintenance can be performed on- site without disturbing transmitter operation. This one point calibration feature saves down time, reduces service costs, and ensures high accuracy operation.



Specifications:

Relative Humidity

Measurement range: 0 to 100%

Accuracy: ±1.0 %RH

Response time: 10 s (63% change)

Temperature

Measurement range: -40° to +140°F (-40° to +85°C)

Accuracy: ±0.1 K

Analog outputs: 4 to 20mA

Operating temperature range of transmitter: -40° to +140°F (-40° to +60°C)

Dimensions: 129mm W x 72mm H x 45mm D, excluding probes

Sensor requires 24VDC Power (Current Draw <100 mA).

Type	US Part #
Standard: Use with Centron (Wall Mount)	HUM-RT1
Battery back-up	HUM-BAT-BACK

All specifications are subject to change without notice.

DC-Input Single Channel Signal Isolator

Use the single channel isolator to measure CO₂ and humidity levels in incubators with chart recorder outputs. Useful in eliminating ground loops, converting signal levels, and providing signal drive, the sensor completely isolates the input and output signals from each other and from ground. Input and output ranging is field selectable. The main application is converting 0 to 1 volt chart recorder outputs to a 0 to 5 volt signal that the Centron can use. Incubators commonly have 0 to 1 volt signals for CO₂ and humidity.

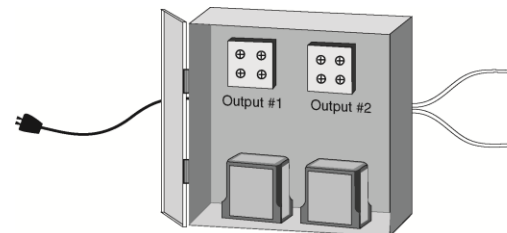

Specifications:

- **Number of Inputs:** 1.
- **Applicable Input types, Current:** 0-(1,5,10,20,50,100) mA.
- **Applicable Input types, Voltage:** (1, 5, 10) VDC.
- **Power Supply:** 12 or 24 VDC/AC 40 to 400 Hz.
- **Isolation:** 1500 VAC.
- **Temperature Range (operating):** 32 to 131°F (0 to 50°C).
- **Linearity:** 0.1%.
- **Drift:** ±0.02% per °C typical, ±0.05% maximum.
- **Input Impedance - Current:** 10 ohms.
- **Input Impedance - Voltage:** 1 Megohm.
- **Dimensions:** 7.25" W x 8.25" H x 3.5" D

Type	US Part #
Use with Centron	ISO-SIG-LV

Relative Humidity Sensor (Wall Mounted)

For use in energy management control systems, clean rooms and computer rooms, industrial process control, environmental chambers and testing, and storage areas for humidity sensitive products.



Specifications:

- Analog Output: 4-20 mA
- Humidity probe recovers from condensation, resists chemical vapors.
- **HUMIDITY-2PCT has an accuracy of +/-2% from 10-95%RH**
- **HUMIDITY-3PCT has an accuracy of +/-3% from 10-95%RH**

Type	US Part # for +2%	US Part # for +3%
Use with Centron	HUMIDITY-2PCT	HUMIDITY-3PCT

All specifications are subject to change without notice.

Relative Humidity Sensor (Duct Mounted)

For use in duct mount applications such as energy management control systems, clean rooms, animal rooms and computer rooms, industrial process control, environmental chambers and testing, and storage areas for humidity sensitive products.



Specifications:

Humidity:

- Measurement Range: 0-100%RH
- Accuracy: $\pm 2\%$ from 20%-95%
- Operating Temperature Range: -20°C to 50°C Operating
- Humidity Range: 0-95%RH non condensing
- Duct Probe Length: 7.15"

Type	US Part #
Humidity	HUM2-DUCT

All specifications are subject to change without notice.

High Temperature Humidity Sensor

Humidity sensor for high temperature applications such as stability chambers and incubators *(non condensing). Sensor is wall mounted for remote probe installation.



Specifications:

- Analog Output: 4-20mA
- Supply Voltage: 24VDC
- Operating Temperature Range: -40°C to + 60°C
- Measurement Range: 0-100%RH *(Non Condensing)
- Accuracy: +/- 2% from 10 to 100%
- Cable Length: 20'
- Probe Diameter: 0.97"
- Probe Length: 4.5"
- Probe Tubing Material: 304 Stainless Steel

Type	US Part #
Humidity	HUM2-HT-R

**Measurement range to change in the near future.

All specifications are subject to change without notice.

Space (Wall) Mount Relative Humidity Transmitter

Monitors ambient humidity for use in laboratories, clean rooms and server rooms. Specially designed enclosure provides enhanced airflow, thereby increasing sensor response time and virtually eliminating the potential of “self-heating” by transmitter electronics that can lead to decreased accuracy measurements.

Not recommended for use in stability or environmental chambers, outdoor applications, or other extreme environments. For use in these applications, refer to Part # HUM-VA1-REM.

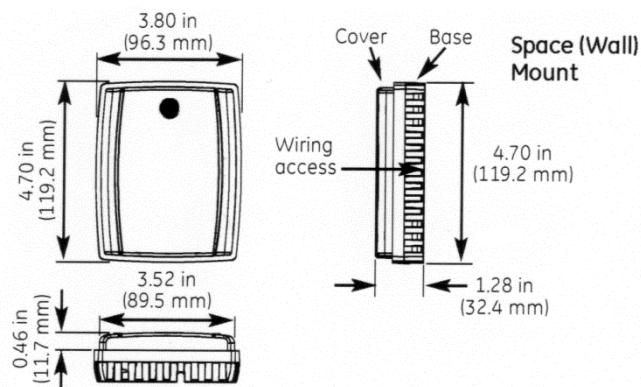

Specifications:

Operating Range: 0% to 99% RH (non-condensing)

Sensing Element: Capacitive polymer sensor

Accuracy at 71.60 F (220 C):

- ±2% version: ±2% 10 to 90% RH
- ±5% 0 to 10 % & 90-99 % RH

Long Term Stability: Less than 1% drift per year, typical

Temperature Effect:

$\Delta \%RH = (0.0014 \times \%RH + 0.1325) \times T0C - (0.0317 \times \%RH + 3.0876)$

Signal Outputs: 4 to 20mA, 0 to 5V or 0 to 10V (user selectable).

Supply Voltage: 24 Volts DC.

Case: ABS Flame Retardant Mounts on single gang box. Rear wire entry.

Type	US Part #
Relative Humidity Transmitter	HUM-ML2

All specifications are subject to change without notice.

Temperature-Light-Humidity Modules

Sensmod TLH is a humidity, light, and temperature sensor designed for animal room monitoring applications where the area is subject to periodic washdowns. The sensor module consists of a 2% humidity sensor combined with a Type 2 thermistor probe and a CDS photo cell light sensor for lights on vs. lights off monitoring.

Sensmod TH does not have the CDS photo cell light sensor.



Specifications:

Sensmod TH & TLH

Relative Humidity

Measurement Range: 0-95%RH

Accuracy: $\pm 2\%$ from 20%-95%

Analog Output: 4-20mA

Temperature

Measurement Range: -15°C to $+60^{\circ}\text{C}$ ($+5^{\circ}\text{F}$ to $+140^{\circ}\text{F}$)

Accuracy: $\pm 0.1^{\circ}\text{C}$ from 0°C to $+60^{\circ}\text{C}$

$< \pm 0.2^{\circ}\text{C}$ from -15°C to 0°C

Analog Output: Thermistor (TPT2)

Operating temperature range of transmitter: -23°C to $+50^{\circ}\text{C}$ (-10°F to $+122^{\circ}\text{F}$)

Operating humidity range of transmitter: 0 to 95%RH non-condensing

Light (only applicable to Sensmod TLH)

Sensor: CdS Photo cell

Power

Supply voltage: 24VDC

Supply current: 24mA Max

Dimensions: Box 3.7x3.7x2.2 Probe 4.6

Type	US Part #
Light-Temperature-Humidity	SENSMOD-TLH
Temperature-Humidity	SENSMOD-TH

All specifications are subject to change without notice.

Temperature-Humidity Modules

Sensmod TH-F is a combination humidity and temperature sensor designed for animal room monitoring applications where the area is subject to periodic washdown.

The sensor module consists of a 2% humidity sensor combined with a Type 2 thermistor probe.



Specifications:

Sensmod TH-F

Relative Humidity

Range: 0-95%RH

Accuracy: $\pm 2\%$ from 20%-95%

Temperature

Measurement Range: -15°C to $+60^{\circ}\text{C}$ ($+5^{\circ}\text{F}$ to $+140^{\circ}\text{F}$)

Accuracy: $\pm 0.1^{\circ}\text{C}$ from 0°C to $+60^{\circ}\text{C}$

$\pm 0.2^{\circ}\text{C}$ from -15°C to 0°C

Analog Output: Thermistor (TPT2)

Operating temperature range of transmitter: 0°C to $+50^{\circ}\text{C}$ (32°F to $+122^{\circ}\text{F}$)

Operating humidity range of transmitter: 0 to 95%RH non-condensing

Power

Supply voltage: 24VDC

Supply current: 24mA Max

Type	US Part #
Temperature-Humidity Flush Mount	SENSMOD-TH-F

*NOTE: Sensor is mounted in a wall plate instead of a wall mounted box. Wall plate material: 304 Stainless Steel.

All specifications are subject to change without notice.

Manual Lighting Override Timer

For those facilities still controlling room lighting with a mechanical timer, the override timer can be used with the Centron monitor to insure that when someone enters an area and overrides the lighting control, that the lighting will return to its proper state automatically, even if you forget to reset.

The timer has a programmable digital display from 0 to 100 minutes. If you need to enter the room during a time when the lights are scheduled to be off, just enter the number of minutes that the override is to be in effect. You reset the timer when you leave. If you forget to reset the timer, the lights shut off when the time you originally programmed runs out.

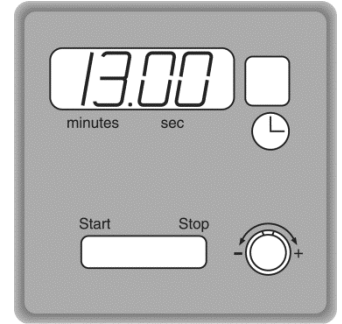

Specifications:

- Microprocessor-based interval time switch.
- Switching 15 amp relay.
- Audible timeout alarm.
- Previous setting kept in memory to facilitate repeat operations.
- Large, easy to read LED display.
- Bit generator to 'dial-in' desired times.
- Manual Start/Stop and Reset buttons.
- Minimum 1 minute power hold-up.
- Several maximum time interval ranges available.
- Dimensions: 2.75" x 2.75"

Type	US Part #
Interval Countdown Timer	LIGHT TIMER

All specifications are subject to change without notice.

Oxygen Sensor

This sensor uses electrochemical gas sensor to detect the level of oxygen in room air. The sensor is used in refrigeration rooms, oxygen storage rooms, 'freezer farms', bone marrow labs, IVF labs, etc., anywhere low Oxygen levels might occur. It is also used where you have freezers with CO2 backup tanks in a confined space. The sensor provides an analog output of 4-20 mA DC linear output.

* Not to be used in a life safety application.

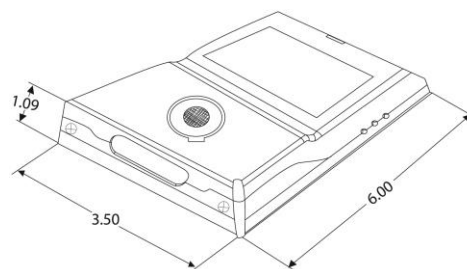

Specifications:

Factory Set Range: O₂, 0 to 25%

Accuracy: ± 2.5% of reading

Repeatability: ± 1% of reading Input

Power: 24 Volts DC

Enclosure Materials: Polycarbonate / ABS blend

Fire Retardant

Temperature: -20° C to 40° C

Humidity: Continuous 15 to 90% RH, non-condensing

Intermittent 0 to 99% RH, non-condensing

Pressure: Atmospheric ± 10%

Response Time: Less than 60 seconds for 90% of step change

Sensor Type: Electrochemical

Sensor Life: Typical 2 to 3 years

Output Signal: Analog, 4-20 mA

Mounting: Screw mounts to a standard 2" x 4" electrical junction box.

Dimensions: 6"h x 3.5"w

Type	US Part #
Oxygen Sensor	.OXYGEN-ROOM

All specifications are subject to change without notice.

Single Phase Power Line Monitor

This transducer is used to monitor the 115V or 220 VAC single phase voltage being supplied to critical equipment. It comes with a standard wall plug for easy installation.

It is designed to be plugged into the same duplex outlet used by the equipment.

NOTE: This sensor is not designed to alarm if power is removed because the equipment is unplugged or turned off by its ON/OFF switch.

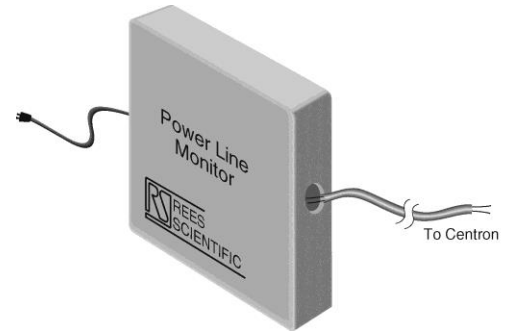

Specifications:

Input: 115 or 220 VAC single phase - field selectable.

Output: 0-5 VDC proportional to input voltage.

Dimensions: 5.375" H x 5.375" W x 2.125" D

Type	US Part #
Use with Centron	PLM-115

All specifications are subject to change without notice.

3 Phase 220/440 Power Line Monitor

This solid state unit continuously monitors three phase lines for phase loss, low voltage, phase reversal, and phase unbalance. The output relay is energized under normal conditions, and de-energized while at fault. The unit automatically resets when the fault is corrected. This monitor can be used on WYE or DELTA systems since no neutral is required.

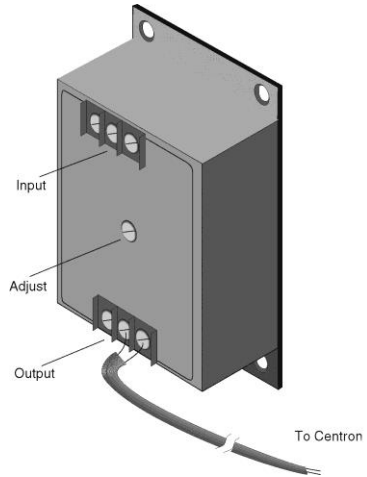

Specifications:

Input: 60 cycle, 160VAC to 240VAC adjustable.

Output: Single pole double throw relay.

Input: 60 cycle, 380ACV to 480VAC adjustable.

Output: Single pole double throw relay.

Dimensions: 3.88" W x 6" H x 2" D

Type	US Part #
Use with Centron	PLM-220
Use with Centron	PLM-440

Large Diaphragm Pressure Switch

The PSSW-DUCT is an economical and reliable solution for monitoring airflow into animal rooms. Installed in the supply duct of each animal room, this SWITCH sensor has a field adjustable set point. The PSSW-DUCT, with an operating range measured in inches of water column, is available in five different ranges.

WARNING: The PSTR-DUCT only reads positive pressure differences. It does not go less than zero. To detect reversals in pressure, or to be able to measure either positive or negative pressure, depending upon the function of the room, use the Negative to Positive Differential Pressure Transmitter.

Specifications:

- Diaphragm, 7.75", with visual set point adjustment. 1% repetitive accuracy.
- Temperature limits: -30° F. (34°C.) for dry air or gas to 110° F., (43° C.)
- Maximum pressure surge: 25 psig.
- Rated pressure: 10 psig.
- Pressure connections: .125" NPT.
- Electrical rating: 15 amps, 120-480 volts, 60 Hz. AC.
- Resistive 1/8 HP @ 125 volts, 1/4 HP @ 250 volts, 60 Hz. AC.
- Wiring connections: 3 screw type, common, normally open and normally closed.
- Set point adjustment: Screw type with enclosed scale.
- Housing: 16 ga. steel, zinc plated, dichromate dipped for 200 hour salt spray test.
- Diaphragm: Silicone rubber with aluminum support plate.
- Calibration spring: Stainless steel.
- Weight: 4 lbs. 14 oz.
- Installation: Diaphragm vertical.
- Dimensions: 7.75" diam. x 6.5" deep

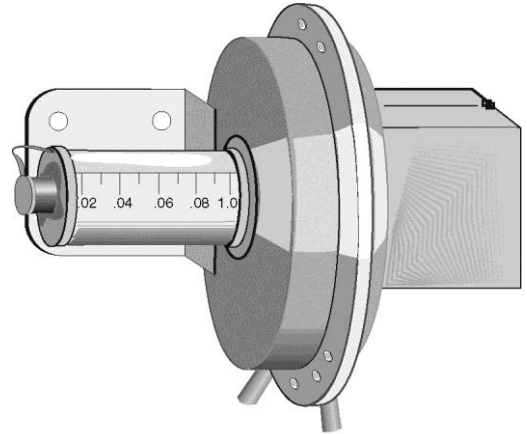

Type		US Part #
Operating Ranges, Dead Bands and Ratings		Use with Centron
Operating Range, Inches, W.C	Approx. Dead Band At Min. Set Point	At Max. Set Point
0.05-0.25	0.04	0.05
0.20-1.0	0.04	0.06
1.0-3.0	0.06	0.08
2.0-6.0	0.07	0.25
3.0-12	0.11	0.30
		PSSW-DUCT-1
		PSSW-DUCT-2
		PSSW-DUCT-3
		PSSW-DUCT-4
		PSSW-DUCT-5

All specifications are subject to change without notice.

Pressure Switch

Use the PSSW-2 to monitor CO₂ pressure to an incubator to determine when to change the tank. It is also used for general low pressure monitoring of compatible fluids.

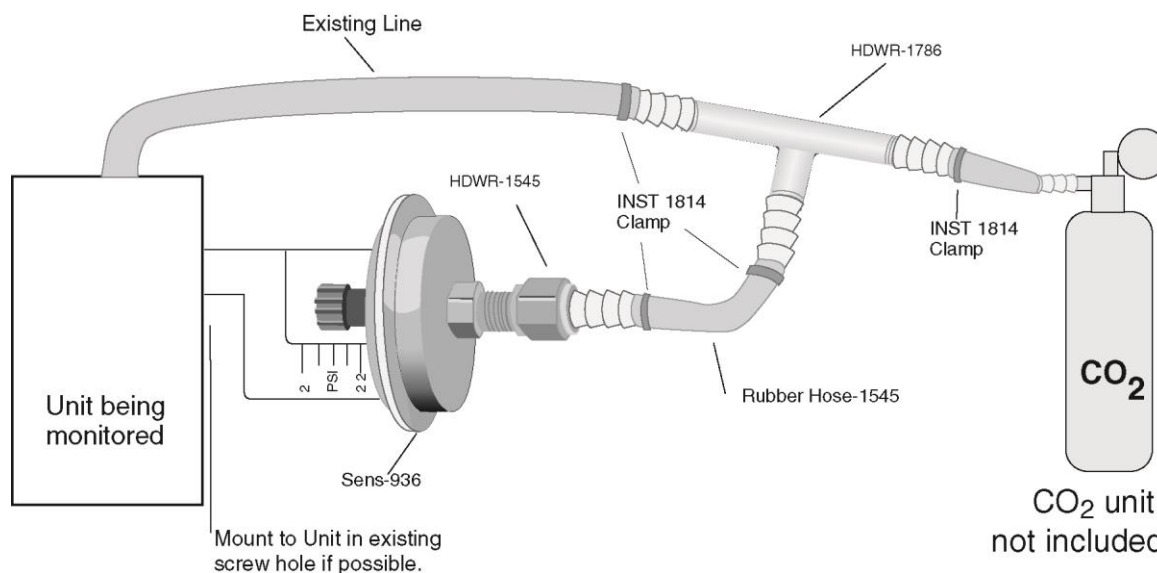

*NOTE: When a PSSW-2 Sensor is ordered, all the parts listed above, with the exception of the CO₂ unit and the unit being monitored, are supplied.

Specifications:

The PSSW-2 provides a switch closure output dependent upon a field adjustable set point. The range is 2 to 22 PSIG. The switch will activate when the pressure is greater than the set point, and deactivate when the pressure is below the set point. The switch is a single pole double throw configuration.

Switch: SPDT

Electrical connection: 1/4" quick connect, male.

Rating: 20 amp to 277 VAC @ 160° F for 100,000 cycles.

Range: 2 to 22 PSIG

Max. Operating Pressure: 75 PSIG

Operating Temperature: 0° C to 87° C., (32°F to 190° F.)

Pressure media: Non corrosive fluid compatible with 300 series stainless steel and BUNA-N.

Pressure connection: 1/4" hose barb – male

Dimensions: 1.875" Diam., x 3.25" L

Type	US Part #
Use with Centron	PSSW-2

All specifications are subject to change without notice.

Differential Pressure Transmitter

The differential PSTR-DUCT is used to measure the pressure differential between two points, such as between a room and the hallway. It reads out in positive INCHES OF WATER. The PSTR-DUCT is available in several ranges, so it is necessary to know the pressure in inches of water column in order to specify the proper model. If you need to monitor negative pressure, or monitor for pressure reversals, use model # PSTR-DUCT-NP Negative to Positive Differential Pressure Transmitter.

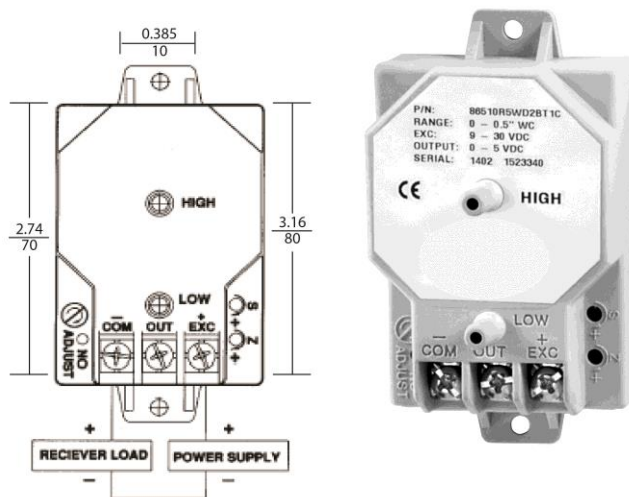

Specifications:

- Maximum Pressure: 10 PSI (0.7kg/cm²).
- Media Compatibility: Air or non-conducting gases.
- Power Supply: 9 - 30 VDC
- Output Signal: 4 to 20 mA DC, two wires loop-powered.
- Current consumption: 4 mA DC (unidirectional pressure ranges)
12 mA DC (bidirectional pressure ranges)
- Materials: Stainless steel diaphragm and insulated stainless steel electrode
- Weight: 3 ounces.
- Span & Zero Adjustments: Factory set to specified range. Externally accessible for fine adjustment. Non-interactive.
- Pressure Connection: 1/4" O.D. pressure fittings with 1/4" push-on tubing.
- Performance at 70o F:
- Zero Output: 4 mA DC (unidirectional); 12 mA DC (bidirectional)
- Accuracy (incl. linearity, hysteresis, repeatability): ± 1% of full span output.
- Operating Temperature: 0oF to +150oF (-18oC to +65oC)

Type	US Part #
Differential Pressure Transmitter 0 to .25" (Requires HUM-BAT-BACK)	PSTR-DUCT-A
Differential Pressure Transmitter 0 to .5" WC (Requires HUM-BAT-BACK)	PSTR-DUCT-B
Battery Backup	HUM-BAT-BACK
Calibration of Differential Pressure Sensor using an NIST Traceable manometer	CAL-DIFF-PRES

All specifications are subject to change without notice.

Negative to Positive Differential Pressure Transmitter

This high accuracy differential PSTR-DUCT-NP is used to measure the pressure differential between two points, such as between a room and the hallway. It can read both positive and negative pressure so that you can use it to detect reversals in pressure. It reads out in *INCHES OF WATER*. The PSTR-DUCT-NP combines very low ranges with exceptional stability, reliability, and $\pm 0.5\%$ accuracy for the most demanding applications. This unit is designed to resist shock and vibration, practically eliminating drift. The unit is certified to NIST standards. It is available in several ranges, so it is necessary to know the pressure in inches of water column in order to specify the proper model.



Specifications:

- Maximum Pressure: 10 PSIG (0.7kg/cm²).
- Media Compatibility: Air & non-conductive, non-corrosive gases.
- Power Supply: 13 - 36 VDC unregulated.
- Output Signal: 4 to 20 mA DC, two wire.
- Loop Resistance: 0-1045 ohms, $V_{min.} = 13V + [(.022A)(RL)]$.
- Current consumption: 3.6 mA DC (min.).
- Materials: Ultra thin glass clad silicon diaphragm. Stainless steel housing (NEMA-2).
- Weight: 14 ounces.
- Span & Zero Adjustments: Factory set to specified range. Externally accessible for fine adjustment. Non-interactive.
- Pressure Connection: Barbed, stainless steel for 1/4" I.D. tubing.
- Performance at 70° F:
 - Zero Output: 4 mA DC; Full Span Output: 20 mA DC
 - Accuracy (incl. linearity, hysteresis, repeatability): $\pm 0.5\%$ of full span output.
 - Stability: $\pm 1\%$ of full span/year. Warm-up Time: 15 seconds.
- Operating Temperature: (10-95% Rh, non-condensing) -20 to 160°F (2 to 57°C)
- Storage: -40 to 180°F (-40 to 82°C)
- Dimensions: 4.2" H x 4.6" W x 1.825" D

Type	US Part #	Range in Inches of Water
Use with Centron	PSTR-DUCT-NP	-.50 to +.50
Calibration of Differential Pressure Sensor using an NIST Traceable Manometer.	CAL-DIFF-PRES	

All specifications are subject to change without notice.

Pressure Transmitter

This pressure transmitter is capable of measuring pressure in process lines. It's compatible with a wide variety of gases and liquids (subject to material compatibility). It provides excellent accuracy and reliability in commercial, industrial, and process control applications.



Specifications:

- Accuracy: +/- 0.5% Full Scale Output
- Burst Pressure: 3X Full Scale
- Materials of construction (Wetted Parts): 304L and 316L Output Signal: 4-20mA
- Pressure Range: 0-50 PSI
- Process Fitting: 1/4" NPT
- Weight: < 0.25 lbs

Power:

- Supply Voltage 24VDC

Type	US Part #
Pressure Transmitter	PT-0-50

*Also available PT-0-100, PT-0-300 & PT-0-500

All specifications are subject to change without notice.

Rotation Sensor

The Rotation sensor is used to detect the motion of platelet rotators. An electrical pulse is generated every time the magnet that is mounted on the rotating equipment passes the Rotation sensor. If this pulsing electrical signal stops, the monitor goes into alarm.

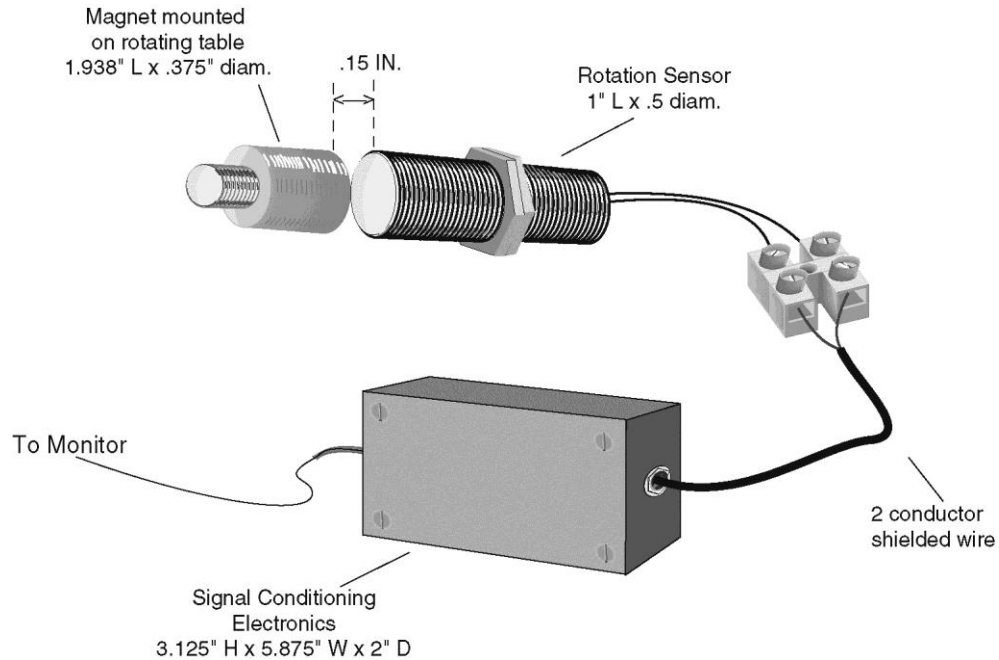

Specifications:

- Supply Voltage: 5 VDC @ 10mA
- Output Voltage: 5 VDC in alarm; 0 VDC in motion
- Min. Frequency: 1 pulse in 20 seconds
- Max. Displacement: .15 inches
- Programming: Program as switch input; alarm when high
- Alarm delay = 0 minutes
- The pluggable rotation sensor comes with a 3.5mm sensor plug on 25 feet of shielded wire.

Type	US Part #
Use with Centron	ROTATE-1

Shaker Sensor

The Shaker sensor is used to detect motion on shaker tables. The Shaker sensor translates a motion into an electrical signal that can be monitored by the Centron. As long as the sensor continues to move, it generates a signal that keeps the monitor out of the alarm state.

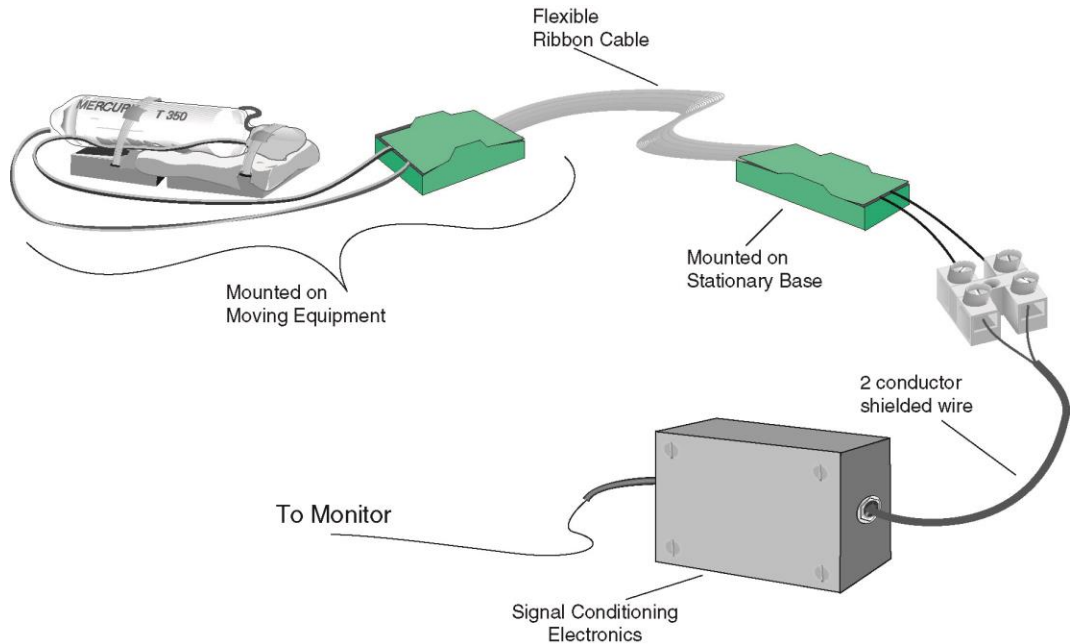

Specifications:

- Supply Voltage: 5 VDC @ 10 mA
- Output Voltage: 5 VDC in alarm,
0 VDC in motion
- Min Frequency: .5 Hz
- Min Displacement: .25 In
- Programming: Program as switch input; alarm when high.
- Alarm delay = .5 min.
- The pluggable shaker sensor comes with a 3.5mm sensor plug on 25 feet of shielded wire.

Type	US Part #
Use with Centron	SHAKE-1

All specifications are subject to change without notice.

Surface Water Detector

Detect water in computer rooms, document storage areas, warehouses, bone marrow rooms, any place where water can cause damage and loss. Detect leaks, monitor sump pumps, cage wash rooms, and sprinkler systems. The sensor is designed to detect water, but it will not alarm due to condensation or high humidity.

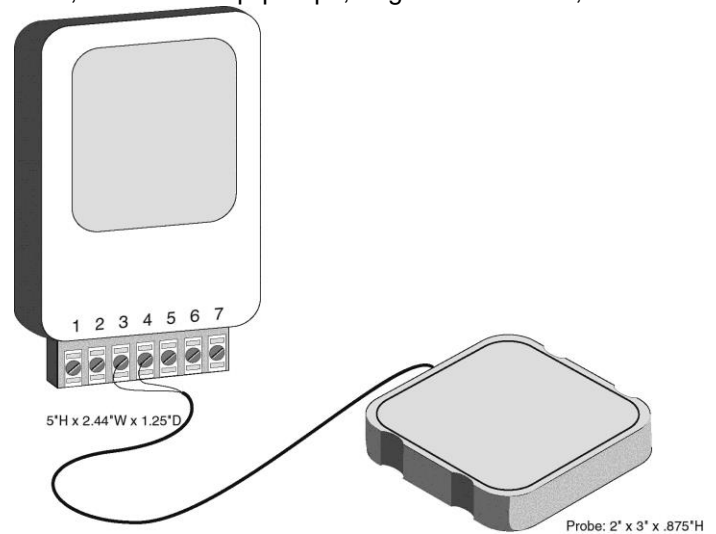

Specifications:

- Each sensor can be connected to up to six (6) probes and can cover a distance of up to 100 feet from the wall mounted sensor.
- Power requirement: 8-14 VDC.
- Current draw resting state: 3.5 mA at 12 VDC.
- Current draw alarm condition: 43 mA at 12 VDC.
- Sensitivity: Will not alarm due to high humidity or condensation.
- Each probe has 2 contacts. A film of water, forming a bridge between them, is needed for an alarm condition.
- Operating temperature: Control unit - 32° to 140°F., (0° to 60° C.)
Probe - 32° to 140° F., (0° to 60° C.)
- Relay rating: 1 Amp at 24 VAC, resistive.
- Relay specifications: 1 Amp at 30 VDC, resistive.
- Each sensor comes with one probe.

Type	US Part #
Standard: Use with Centron	SWD-1
Additional Probes	SWPR

All specifications are subject to change without notice.

Light Sensor

The PHOTO-P1 is designed for use in applications where it is only necessary to know if the lights are on or off. Its principal application is in animal rooms and plant growth chambers.



Front View

Side View

Specifications:

- CDS photo cell mounted on a stainless steel plate which can be mounted in a single gang box. It is epoxy sealed and water resistant.
- Dimensions: 2.75" W x 4.5" H

Type	US Part #
CDS	PHOTO-P1

All specifications are subject to change without notice.

Ambient Temperature Sensor

The TPT-2-Ambient sensor is designed specifically to monitor ambient room air temperature. The unit is a stainless steel plate with the sensor protruding through the face of the plate. The junction of the plate and the sensor is gasketed for water resistance. This sensor is useful in HVAC applications to monitor and/or control room temperature; i.e. computer rooms, animal rooms, file storage rooms, packaging rooms, with bench testing, freezer rooms, etc. Monitoring the ambient temperature in a room full of freezers gives you warning if the room air handler goes down, preventing compressor overload.



Specifications:

- Temperature sensor provides great sensitivity and fast response time.
- Connections are sealed against moisture.
- Can be installed onto a single gang box.
- Dimensions: 2.75" W x 4.5" H

Thermistor Temperature Range
Probe "TYPE": 2 Resistor: 4990 ohm Range: (°C) -15 to +60 Range: (°F) +5 to +140

Type	US Part #
Ambient Air Sensor with Wall Plate Temperature Probe	TPT-2-A
3 Point Calibration per Input. Minimum of 5 Points Required. Must be Completed at Time of Validation.	CAL-3POINT
Fire and Ice Test per Input. Minimum of 5 Points Required. Must be Completed at Time of Validation.	CAL-FIRE-ICE

All specifications are subject to change without notice.

Cryogenic Thermistor Probe

This device constitutes an excellent alternative to our thermocouple amplifier for the monitoring levels of liquid nitrogen freezers and Dewars. The Cryo-6 probe is a good level sensor and is useful for determining when liquid nitrogen tanks need to be refilled. When the liquid nitrogen goes below the probe level, the temperature above increases and sets off an alarm. It's time to refill the tank. Disconnectable probes are available for situations where equipment is routinely moved or switched around. A programming change is all that is required when probes are moved to new equipment.

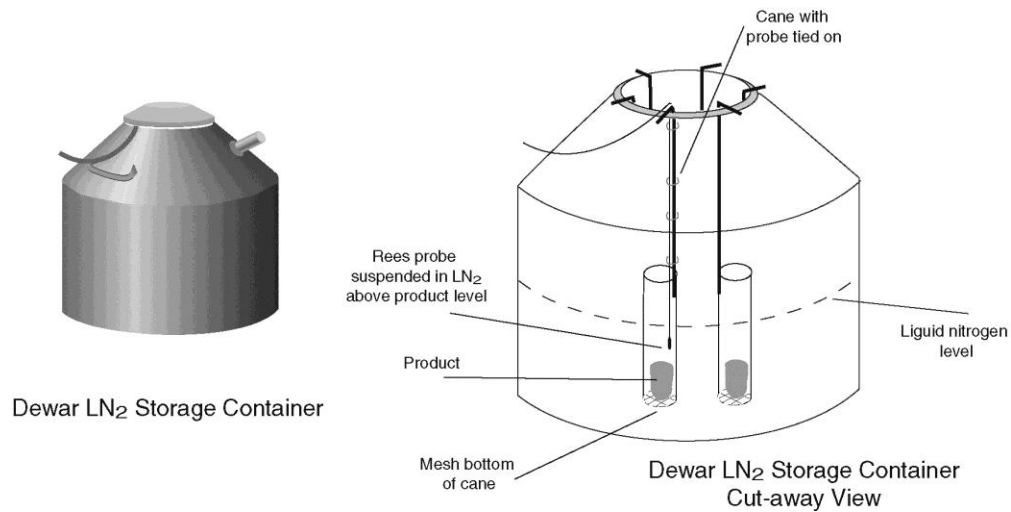

Specifications:

- This probe is similar to our standard thermistor probe in physical structure, but it is designed with a -125 to -200° C. temperature range. These probes are stable and are accurate to within 1° C. once calibrated at the liquid nitrogen temperature of -196° C. With deviation from the calibrated temperature their temperature accuracy decreases.
- Approximate errors are $\pm 2^\circ$ at ten degrees from the calibrated point, and $\pm 6^\circ$ at 60° from the calibrated point.
- Pull-up resistor value at remote panel is 3.01K for standard, non-disconnectable probes.
- The Cryo-6 probe can be used with the Centron.
- The disconnectable probe has 15' of wire with a 1/4" plug, and a wall plate with jack .
- The 1/4" disconnectable probe requires a 100K pull up resistor between sense and +5 volts that are remote panel.
- Dimensions: Probe: 2.75" L x .25 diam.

Type	Temperature Ranges		US Part #
	(Deg. C.)	(Deg. F.)	
Standard: Use with Centron	-200 to -125	-328 to -193	CRYO-6
Standard: Use with Centron	-200 to -125	-328 to -193	P-CRYO-6
Fire and Ice Test per Input. Minimum of 5 Points Required. Must be Completed at Time of Validation.			CAL-FIRE-ICE

All specifications are subject to change without notice.

Thermistor Probes

The thermistor is a high precision temperature sensitive resistor made to read in a preset temperature range. The TPT series is most commonly used for ambient temperature readings in animal rooms, refrigerators, freezers, incubators, growth chambers, and greenhouses.

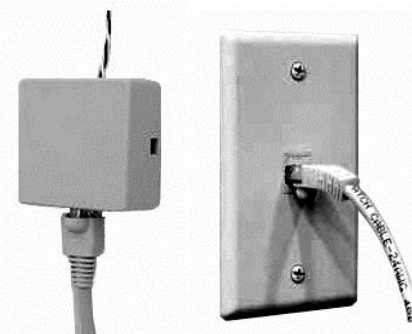

Specifications:

- Sensor Accuracy: Mfr. Specified resistance curve within 0.2 degrees C from 0-70 degrees C.
- Typical un-calibrated accuracy at -50° C: $\pm 0.5^\circ$ C.
- Typical un-calibrated accuracy at -80° C: $\pm 1^\circ$ C.
- Dimensions: 2.75" L x .25" Diam

Standard Order #	Standard Probe Pull-up Resistor at Remote Panel	Thermistor Temperature Ranges		Color	Resolution over Range	3 Pt NIST Certificate
		Deg. C	Deg. F			
TPT1	1000 ohm	+40 to +105	+104 to +221	Orange	+/- 0.1 Deg. C	TPT1-CERT
TPT2	4990 ohm	-15 to + 60	+5 to +221	Red	+/- 0.1 <80 Deg. C +/- 0.2 >80 Deg. C	TPT2-CERT
TPT3	30100 ohm	-50 to +30	-58 to + 86	Yellow	+/- 0.1 Deg. C	TPT3-CERT
TPT4	100000 ohm	-90 to +10	-130 to +50	Blue	+/- 0.1 Deg. C	TPT4-CERT
TPT-2-HD	4990 ohm	-15 to + 60	+5 to +221	Red	+/- 0.1 <80 Deg. C +/- 0.2 >80 Deg. C	

Type	US Part #
3 Point Calibration per Input. Minimum of 5 Points Required. Must be Completed at Time of Validation.	CAL-3POINT
Fire and Ice Test per Input. Minimum of 5 Points Required. Must be Completed at Time of Validation.	CAL-FIRE-ICE

All specifications are subject to change without notice.

Temperature Block

The Temperature Block is a temperature probe stabilizer. It prevents false alarms due to temporary temperature fluctuations caused by normal events such as door opening. When used in conjunction with a temperature probe, it accurately predicts stored product temperature and is designed with independent calibration port for detailed calibration/validation. Made from aluminum that's anodized for superior protection and has a hexagonal design which allows mounting in any position as the block stays in place. It is engineered to work in conjunction with existing Rees Scientific temperature probes.



Specifications:

- Available Ports: TPT Port, Calibration Port
- Material: Anodized Aluminum
- Dimensions: Hex 1.25"x 2.25"

Type	US Part #
Temperature Block. Probe not included.	.Temp-Block

All specifications are subject to change without notice.

Temperature Stabilization (Equalization) Kit – Glycol

The glycol kit is used to suspend a probe, located in a refrigerator or freezer, in a solution of antifreeze (provided by the user) to cause temperature readings to reflect product temperature rather than instantaneous box temperature.

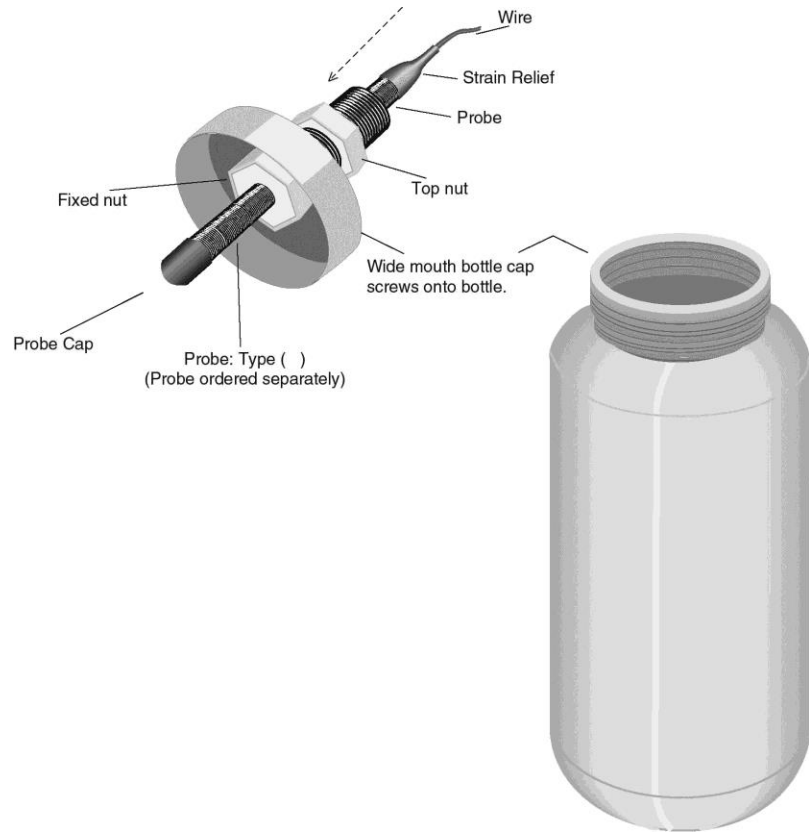

Specifications:

- 250ml plastic bottle
- Dimensions: 2.25" Diam. x 5.125"H

Type	US Part #
Glycol Bottle and cap assembly. Probe not included	GLYCOL-KIT

All specifications are subject to change without notice.

Temperature Stabilization (Equalization) – Kit Sand

The temperature stabilization kit is used to suspend a probe, located in a refrigerator or freezer, in a sealable container filled with sand. Using the kit enables the probe to get temperature readings that reflect product temperature rather than instantaneous box air temperature. Sand is ecologically friendly, with no disposal problems.

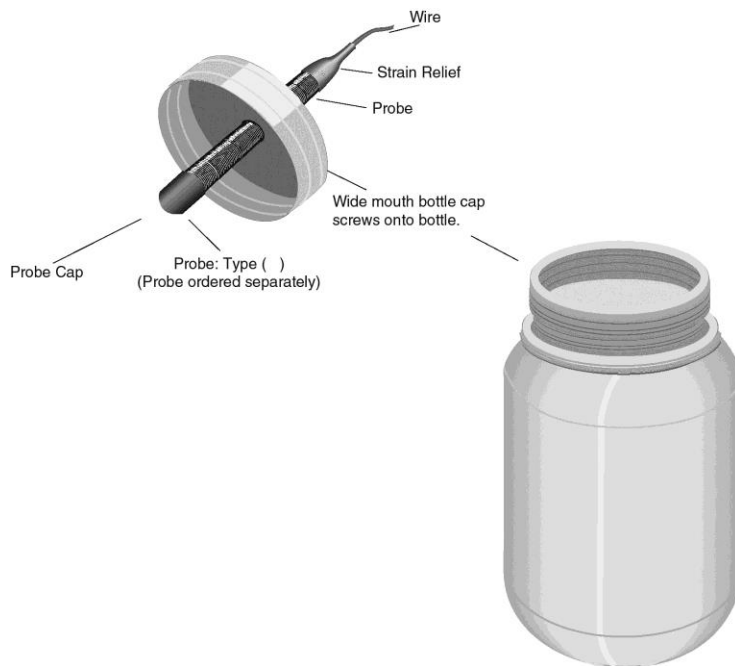

Note: Blood Bankers may want to refer to their compliance manuals before purchase.

Specifications:

- 1 plastic bottle filled with sand.
- 1 lid, predrilled with a hole for your probe.
- Dimensions: 2.25" Diam. x 3.25"H

Type	US Part #
Bottle and cap assembly, including sand. Probe not included.	TEMP-KIT

All specifications are subject to change without notice.

Z3 RTD Temperature Sensor

Rees Scientific Z3 Zigbee Universal wireless transmitter for 1 input uses an advanced fifth generation Zigbee protocol stack that has been optimized for extremely efficient communications. These transmitters come with PT-100 platinum RTD sensors. They read from -200 to +100 degrees C with typical accuracy over span of 0.4 degrees and a resolution of 0.07 degrees. Transmitters buffer 7 days of readings history recorded at 5 minute intervals. Battery life is approximately 1.5 years. Certified version reads from -200 to +100 degrees C. with a resolution of 0.07 degrees and is calibrated to 0.1 degrees C accuracy at -196, -50, 0, and 50 degrees C. Certificate is provided. Additional 0.1 degree accuracy calibration point(s) for Z3-RTD-CERT modules available for an extra charge. For each point purchased, up to 16 additional sensors will be calibrated at the specified temperature. NOTE: temperatures in Celsius must be multiples of 10 degrees and must be between -70 C and +100 C.

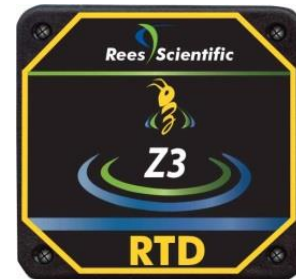

Specifications: RTD Transmitter - Zigbee

- Transmitters buffer 7 days of readings history recorded at 5 minute intervals.
- Most sensors in a typical install will be battery powered.
- Transmitters come with PT-100 RTD sensors and provide 12 bit analog to digital conversion accuracy.
- Range -200 Deg. C. to +100 Deg. C.
- **Certified version** is calibrated to +/- 0.1 Deg. C. accuracy at -196, -50, 0, and 50 degrees (line powered).
- **Non-certified version** is calibrated using an RTD simulator to be 0.1 degree accurate at 0 degrees C. The untrimmed probe accuracy is $\pm(0.30 + 0.005 * t)$ where t is the absolute value of the temperature in degrees C. Sensor can be field calibrated to be accurate at any set point.
- 1 input and 2 input transmitters available.
- Batteries are monitored in battery-powered units. Low batteries cause low battery alarms, which can dial out.
- AC power loss in routers will cause a power loss alarm which can dial out.
- Can be added to existing systems. A single system can contain wired sensors, Wireless Version 1 sensors, V2 and Z3 wireless sensors.
- Dimensions (enclosure) Z3: 2.54 W X 2.54 H X 1 D (inches)
- FCC Certified- FCC ID Z3: MCQ-S2CTH*
- Transmit Power: V2 3 dBm, Z3 8 dBm
- Battery Back Up Duration
- For modules running solely on battery, battery lasts approximately 1.5 year for Z3.
- Modules connected to AC power will perform as routers for other modules.
- In a power outage, AC connected modules will continue as routers for 4 hours, then demote to run efficiently on battery power.
- Batteries last approximately 100 hours in the high-draw state that happens during the first 4 hours of a power outage. Thus, these modules are good for about twenty-five power outages with duration of 4 hours or more.
- 6-7.5 VDC can be supplied using 120 VAC or 230 VAC power supply. Powered units become routers.
- Each router can service up to 20 battery powered children.
- Maximum wireless transmission receiver range indoors approximately 50-75 with standard radios.

Type	US Part #
Single Input RTD Module	Z3-RTD-STD-1
Dual Input RTD Module	Z3-RTD-STD-2
Single Input Certified RTD Module	Z3-RTD-CERT-2
Dual Input Certified RTD Module	Z3-RTD-CERT-2
Additional Calibration Point for certified Modules	Z3-RTD-CALPT

All specifications are subject to change without notice.

RTD Temperature Sensor

When performance and accuracy are a must, Rees Scientific can offer our RTD temperature sensors. These RTD sensors are available in a variety of temperature ranges, all designed to meet your monitoring needs. Rees Scientific can also offer certified RTDs. Certified RTD's include a calibration certificate to verify that the sensor was factory calibrated at five points over the operation range of the sensors. Rees Scientific offers loop calibration services to accompany these certified sensors (must be re-done each year).



Specifications:

- Ranges: -200 to +150°C (See Table)
- Output: 4 to 20 mA
- Sensor: 1K Platinum RTD
- Supply Voltage: 7-35 VDC 24 VDC Nominal
- RTD Sensor Alone: Class B RTD = $\pm(0.30 + 0.005 \cdot t)$ where t is temperature in degrees C
- Accuracy of Module: +/- 1.5 % of sensor span error in the 4-20 mA output signal.
- 6 ft. Sensor Cable
- Calibrated Accuracy: $0.3^{\circ}\text{C} + 0.005 \cdot \Delta T$ where ΔT is the deviation from the calibration point.
- Repeatability +/-0.3°C (+/-0.54°F)

Type	Range	US Part #	5 Pt NIST Certificate
RTD Probe and Transmitter	0 to +150C	RTD 0+150	
RTD Probe and Transmitter	0 to +100C	RTD 0+100	RTD 0+100-CRT
RTD Probe and Transmitter	+10 to +70C	RTD+10+70	RTD+10+70-CRT
RTD Probe and Transmitter	-100 to +30C	RTD-100+30	RTD-100+30-CRT
RTD Probe and Transmitter	-20 to +30C	RTD-20+30	RTD-20+30-CRT
RTD Probe and Transmitter	-200 to +60C	RTD-200+60	RTD-200+60-CRT
RTD Probe and Transmitter	-50 to +50C	RTD-50+50	RTD-50+50-CRT
5 Point Input Calibration to Ensure Overall System Accuracy Using a Certified 4 to 20 mA Sensor. Minimum of 5 Points Required. Must be Completed at Time of Validation.		CAL-LOOP	

All specifications are subject to change without notice.

Thermocouple – Freezers and Cryo Tanks

Thermocouples can be used over a wide range of temperatures. When the temperature to be measured falls outside the range of a standard TPT thermistor probe (< -80° C. or > 105° C.), (< -112° F. or > 157° F.) the thermocouple should be used. It is most commonly used when monitoring liquid nitrogen freezers. This probe is made for freezers that have skinny probe ports where only a thermocouple will reach.

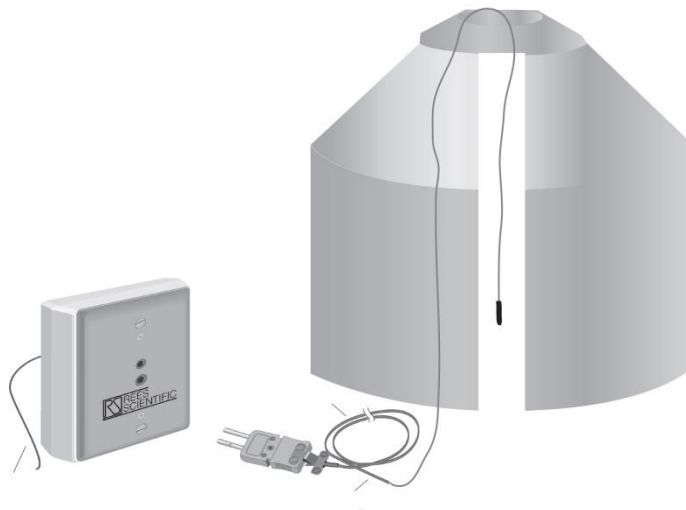

Specifications:

- Range: -270°C to +50 °C Output: 4 to 20 mA
- Sensor: Type K
- Supply Voltage: 8-30 VDC
- Tolerance: ± (0.04% FS + 0.04% rdg) or 0.5°F whichever is greater
- Sensor dimensions: 0.06" x 0.10"
- Thermocouple amplifiers come with Type K thermocouple wire w/plug, in either 15' or 25' lengths.
- Dimensions: 3.125" x 4.75", includes enclosure.

Use the standard thermocouple amplifier with the Centron Presidio.

Type	US Part #
Thermocouple for freezers and cryo tanks w/15' wire	.TC-270+50

Either the Amplifier or the Thermocouple Wire are available as replacement parts. Consult the factory.

All specifications are subject to change without notice.

Combustible Gas Sensor

Monitors ambient air for concentrations of combustible gas in the range of 0-100% of the lower explosive limit.



Features:

- CSA and UL Approved: Class I, Division 1, Groups B, C, & D
- Plug-in field-replaceable transmitter and sensor
- Integral sensor fault diagnostics
- Long sensor life expectancy
- High resistance to poisons such as sulfides, chlorides, silicon-based contaminants etc.
- Low power consumption (less than 3.5 watts versus 8+ watts on competitive brands)

Specifications:

- Sensor Type: Matched-pair catalytic bead
- Measurement Range: 0-100% LEL (lower explosive limit) Combustible Gas
- Accuracy/Repeatability: $\pm 3\%$ 0-50% LEL
 $\pm 5\%$ 50-100% LEL
- Response/Clearing Time: T50 <10 seconds
T90 <30 seconds
- Zero Drift: <5% per year
- Operating Temp. Range: -40°F to +167°F; -40°C to +75°C
- Operating Hum. Range: 0-99% RH non-condensing
- Outputs: Linear 4-20 mA DC
- Input Voltage: 11.5-28 VDC
- Power Consumption: 2.1 watts @ 24 VDC
- Electrical Classification: Explosion proof Class I, Division 1, Groups B, C, D
- Safety Approvals: CSA and UL Approved
- Dimensions: 7.25"H x 6.125" Diam.

Type	US Part #
Use with Centron	CG-Sensor

All specifications are subject to change without notice.

Particle Counter Sensor

Detects microscopic particles in controlled environments and critical processes.



Specifications:

- 0.5 μ m and 5.0 μ m channels
- CFM sample flow rate
- 2 4-20mA proportional current outputs
- Dimensions: 6" x 4" x 11.25"

Power

- 24 VDC @ 0.85A

Operating Temperature

- 0-37°C

Type	US Part #
Particle Counter	PART COUNTER 1

All specifications are subject to change without notice.